CONTENTS

CHAPTER 1. OVERVIEW	1
1.1 OVERVIEW	1
1.2 WHAT IS GPS	1
1.3 FEATURES	1
1.4 CAUTION	1
CHAPTER 2. COMPONENT	2
2.1 STANDARD COMPONENT FOR GPS	2
2.2 STANDARD COMPONENT FOR DGPS	2
2.3 OPTION	2
CHAPTER 3. SPECIFICATION	3
3.1 GPS RECEIVER	3
3.2 DGPS RECEIVER	3
3.3 GENERAL SPECIFICATION	3
CHAPTER 4. INSTALLATION	5
4.1 UNPACKING & CHECK	5
4.2 SELECTION OF INSTALLATION PLACE	5
4.3 POWER CONNECTION	5
4.4 CONNECT WITH EXTERNAL DATA	6
4.5 ANTENNA INSTALLATION	6
4.6 INSTALLATION OF DGPS(OPTION)	7
4.7 INTEGRATED WIRING	8
CHAPTER 5. OPERATION	9
5.1 FUNCTIONS	9
5.2 DESCRIPTION OF FRONT BOARD	15
5.3 DISPLAY SELECTION	17
5.4 DESCRIPTION OF NAVIGATION SCREEN	18
5.5 PLOTTER SCREEN DISPLAY & FUNCTION	20
5.6 HIGHWAY SCREEN SETTING	22
5.7 STEERING SCREEN	24
5.8 USER DISPLAY	26
5.9 MENU	27
5.10 MENU STRUCTURE & INITIAL SETTING VALUE	29
CHAPTER 6. HOW TO SET-UP & PROCESS	30
6.1 NAVIGATION	30
6.2 SET-UP PLOTTER	35
6.3 ALARMS SET-UP	36
6.4 ERASE	39
6.5 DGPS	41
6.6 CALCULATE	42
6.7 MESSAGES	43
6.8 SATELLITE	44
6.9 USER DISPLAY	45
6.10 GPS SET-UP	46
6.11 SYS SET-UP	47
6.12 I/O SET-UP	48
CHAPTER 7. ATTACHMENT: GEODETIC DATUM, ABBREVIATIONS	
CHAPTER 8. BLOCK DIAGRAM	

CHAPTER 1. OVERVIEW

1.1 OVERVIEW

First of all, we appreciate your purchasing SAMYUNG GPS (Model : SPR-1400)

We would appreciate if you read this manual carefully before operation in order to keep the performance of the machine optimize.

SAMYUNG reserves intelligent property rights for software and hardware of SPR-1400, and its related circuit technology information as well, which has been provided to USER under SAMYUNG provisional agreement and permission, which have to be used for the proper purpose. If there found illegal copy of the said SAMYUNG property, that is to be in conflict with related rule and regulation.

GPS is the most advanced navigation equipment so far developed. However navigator should make up his mind not only depending on GPS information while he is in a distress situation.

We guarantee you to provide thorough After Service for SPR-1400 if the case occurs.

1.2 WHAT IS GPS

GPS(Global Positioning System) composes of 24 numbers of Satellites over 6 orbits in general. Satellites turn around circular orbit 20,200 km height, 55' tilt angle at 12 hours a cycle. The interval of this satellite in orbit each other is PDOP=6, which should be positioned with at least 4 Satellites to be seen to worldwide user.

Each satellite transmits with L1(1575.42MHz) and L2(1,227.6MHz) frequency. L1 transmits P and C/A code, L2 transmits P code. All navigation data messages are registered to these code. Identical navigation data is transmitted to both frequencies.

1.3 FEATURES

1. Compliant to IMO and MSC. recommendation.
2. Available with wide range of power and compact size for easy installation.
3. Adapted Graphic LCD with wide view angle, which is efficiently viewable from wide angled direction and facilitates easy operation.
4. Initial set does not require and fast tracking on Satellite is possible.
5. Adjustable on the brightness of backlight for LCD and key pad, which can facilitates to use at night navigation.
6. It can interface in/out data (NMEA-0183 and other format signal) with other equipment.
7. Information for destination, marks and routes can be output and input through PC.
8. There are various display mode, which can be setup by operator for usage at his discretion.
9. It is convenient to operate while in waypoints and route navigation by using plotter function.
10. Various kinds of alarms and self-test function for safe navigation.

1.4 CAUTION

This receiver is manufactured under the strict quality control, which amassed with long experiences in accurate measuring devices, and therefore operator is kindly requested to refrain from changing any components or parts whatsoever in order to keep the performance of it same as it is from factory.

If there has a trouble in the machine during operation, please resort to help at SAMYUNG after service center if possible.

CHAPTER 2. COMPONENT

This unit is composed of following specification.

2.1 Standard components of SPR-1400

ITEM	MODEL	Q'TY	REMARKS
Main Unit	SPR-1400	1 SET	Stainless Band (2 pcs)
GPS Antenna	SAN-60	1 SET	
Antenna Cable	RG-58C/U	10M/20M	
DC Power Cable	VCTF1.25SQ x 2C	3M	
Installation Material		1 LOT	
Instruction Manual		1 LOT	

2.2 Standard components of DSPR-1400

ITEM	MODEL	Q'TY	REMARKS
Main Unit	SPR-1400	1 SET	Stainless Band (2 EA)
DGPS Antenna	SANB-300	1 SET	
Antenna Cable	6P SHIELD	10M/20M	
DC Power Cable	VCTF1.25SQ x 2C	3M	
Installation Material		1 LOT	
Instruction Manual		1 LOT	

2.3 OPTION

ITEM	MODEL	REMARKS
AC POWER SUPPLY	SP-100	

CHAPTER 3. SPECIFICATION

3.1 GPS RECEIVER

1. Antenna

- 1) Center Frequency : 1575.42 MHz
- 2) Dimensions & Weight : 90(H)x65(W)mm (150mm mounting bar) 0.15kg

2. Receiver

- 1) Receiving Frequency : 1575.42±1 MHz
- 2) Receiving Channel : 12 Channels
- 3) Receiving Code : C/A code(1.023 MHz chip rate)
- 4) Tracking Capacity : 12 simultaneous satellite vehicle
- 5) Receiving Sensitivity : Less than -130 dBm
(Less than -133 dBm after capturing the signal)

3.2 DGPS RECEIVER

1. DGPS Antenna

- 1) Type : L1, Flat Plate Type
- 2) Power Supply : Receiver Module
- 3) Dimensions & Weight : 114(H)x115(W)mm (150mm mounting bar) 0.66kg

2. Receiver

- 1) Receiving Frequency : 1575.42±1 MHz
- 2) Receiving Channel : 12 Channels
- 3) Receiving Code : C/A code(1.023 MHz chip rate)
- 4) Tracking Capacity : 12 simultaneous satellite vehicle
- 5) Receiving Sensitivity : Less than -130 dBm
(Less than -133 dBm after capturing the signal)

3. Beacon Receiver

- 1) Receiving Frequency : 283.5 ~ 325.0KHz
- 2) Frequency : 500Hz
- 3) Transmitting Station Selection: Manual/Automatic
- 4) Receiving Mode : MSK
- 5) Receiving Error : Less than 10uV/m
- 6) Error Check : Parity Error Check

3.3 GENERAL

1. Measurements

- 1) Tracking Velocity : 1000 Knots (514 m/s)
- 2) Static Precision Rate : Measuring Error Rate of Antenna at HDOP=4
or PDOP=6
GPS: Within 100m(95%) DGPS: Within 100m(95%)
- 3) Dynamic Precision Rate : Measuring Error Rate of Ship (Sea) at HDOP=4
or PDOP=6
GPS: Within 100m(95%) DGPS: Within 100m(95%)
- 4) Display Resolution Rate : Latitude & Longitude of 1/1000

-
-
- 5) Velocity Precision Rate : 0.1 Knots RMS, HDOP<2.0 (Without SA)
 - 6) Measuring Time : Warm Start Average < 13 Sec
 - 7) Intervals of renewing Data Measurements : 1 Sec

2. Input and Output DATA

- 1) Data 1 : Input RS-232C, Output RS 232C, RS 422 & TTL
 - * Input data : NMEA0183 Ver. 1.5, NMEA0183 Ver. 2.0
 - * Output data : NMEA0183 Ver. 1.5, NMEA0183 Ver. 2.0
- FURUNO CIF
- Input in Personal Computer (Waypoints/Routes DATA)
- Output in Personal Computer (Waypoints/Routes DATA)
- 2) Data 2 : Output RS-422
 - * Output Data : NMEA 0183 Ver. 1.5, NMEA0183 vER. 2.0
- Furuno CIF

3. General

- 1) Display Unit : 128 X 64 Dot LCD (3 inch)
- 2) Display Mode : Plotter Mode, Steering Mode, Highway Mode,
NAV Data mode, User Mode(Digital, Speedometer)
- 3) Screen Zooming
 - * Plotter Mode : 0.02, 0.05, 0.1, 0.2, 0.5, 1, 2, 5, 10, 20, 50, 160, 320nm
- 4) Memory Capacity : WAYPOINT/MARK/MOB (Total 999 points),
Routes 50 points (Each route contains 30 waypoints),
Track 999 points
- 5) Protective Circuit : Any permanent damage does not occur even under the situation of any short circuit or any grounding of antenna, input/output terminals for more than 5 ms.
- 6) Temperature : Antenna = - 40 ~ +85℃ Main unit = -20 ~ +55℃
- 7) Humidity : 95% (+30 ~ +60℃)
- 8) Power supply : DC10 ~ 36V/0.08 ~ 0.3A (Less than Max. 4W)
- 9) Dimensions & Weight : 190(W) X 112(H) X 73(D)mm (Plus Flush Mount.) / 0.9Kg

4. Performance standard

The equipment is designed to comply with the standard requirements as follows;

- 1) IMO performance standard : Res. A. 819(19)
- 2) MSC Performance standard : MSC-112(73)
- 3) ITU-R M.823
- 4) EMC 57&30

CHAPTER 4. INSTALLATION

4.1 Unpacking and inspection

Please dismantle the package with care to check if the contents are same as ordered.

Please also check if external shape is OK during transportation, if there found damages on external shape, please take necessary measures and contact us.

This receiver is designed and manufactured for any vessel's particular, so there seems no difficulties to install it on board except basic guidelines described hereunder.

4.2 Selection of installation place

1. Select the spacious place for efficient operating and maintenance with sufficient ventilation.
2. The place where there should not be exposed to Rain or Seawater.
3. Space for avoiding from sunlight and electric heating sources.
4. Place it at little mechanical vibration taken place.
5. Place it where there is little interference with other electric devices.

4.3 Power Connection

1. 2P connector at the rear panel is for power supply as No.1 is (+), No.2 is (-).
Connect DC power between 10V and 36V.
 2. Connect 2P plug, which is suitable for power supply connector, with 2P cable with care avoiding to change (+), (-) polarity.
- * Power cables supplied as standard package is of white (+) and black (-) colors.

4.4 Connection with external data

1. RS-232 & TTL

Connector is for interfacing with other equipment to input & output the position information.

1) There are 4P connectors at the rear side with the each pin number as follows;

Connector No.	Pin Name	Functions
1	Data RX	Data RX for connecting with external equipment (Input RS-232C)
2	Data TX	Data TX for connecting with external equipment (Output RS-232C)
3	Data TTL TX	TTL Data TX (JRC, FURUNO)
4	Data COM	Data COM for connecting with external equipment

2) The signals from No.2, No.4 pins for connector have same polarities but the signal level of the connector No.3 is outputs from 0V(L) or 5V(H) TTL level.

1. RS-422

This connector is for connecting with other equipment to input & output the position information.

1) There are 5P connectors at the back side with the each pin number as follows;

Connector No.	Pin Name	Functions
1	Data TX(A+)	Data TX A+ for connecting with external equipment (Output RS-422)
2	Data TX(A-)	Data TX A- for connecting with external equipment (Output RS-422)
3	NC	
4	NC	
5	Data COM	Data COM for connecting with external equipment

4.5 Antenna Installation

As GPS antenna affects the performance of the equipment, depending on the installation positions, please pay special attention to the location of GPS antenna according to the external wiring diagram. Keep more than 1m away from other antennas and obstacles.

To make sure the watertightness for the connecting points exposed to outside.

1. When it is necessary to connect to antenna, the power should be turned off. So press **ON/OFF** button in the front panel for about 2 sec.

2. The higher the antenna is installed in any place without interference, the better the performance will be.

3. The farther the antenna is installed away from other antennas, the better the performance will be also.

It is advisable to install it from any antennas of high-power output radar, VHF and UHF, at least far so that the GPS antenna gets as less interference as possible.

These wrong locations might cause the malfunction of both the antenna and the receiver unit.

4. When connecting RF connector, please fasten it tightly so that the main unit of the equipment can be completely connected. And don't forget to make sure RF connector of the antenna should be

waterproofed.

5. When using DGPS antenna, the process of installation is same as that of GPS.

4.6 INSTALLATION OF DGPS

When using DGPS, it is necessary to install DGPS antenna.

1. DGPS antenna: Please refer to "4-5 Antenna Installation"

* Connectors for connecting to DGPS antenna with main units are as follows;

Connector No.	Pin Name	Functions
1	POWER+	Positive Power Input 12 ~ 24V DC
2	POWER-	Negative
3	TRANSMIT	RS-232 OUT
4	RECEIVE	RS-232 IN
5	RECEIVE	TLL-IN
6	GROUND	Signal Ground Common to receive and transmit

* Power input connector in Main unit, which is of DGPS power supply terminal as follows;

Connector No.	Pin Name	Functions
1	+	Power Suply connector from DC10 ~ 36V
2	-	

4.7 Integrated wiring

Integrated wiring including external equipment should be made according to block diagram.

1. DC Power cable should be used with supplier type or cables for enough current capacity.
2. Antenna connector of navigation equipment, power connector, data out connector should be tightened.

<GPS>

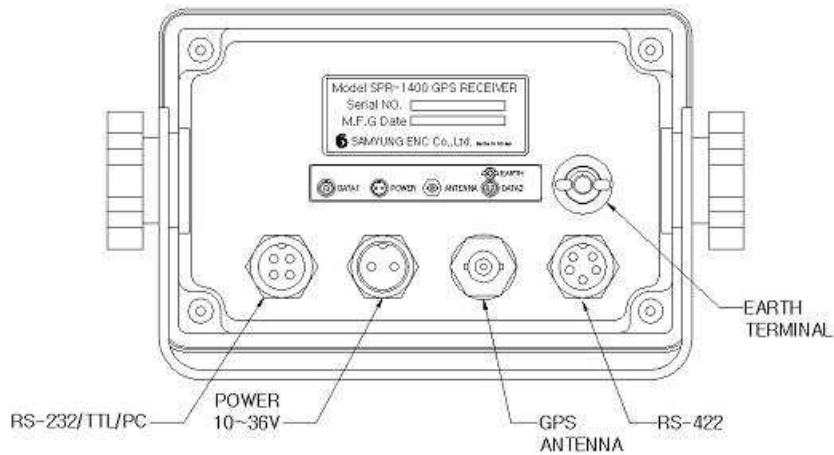

<DGPS>

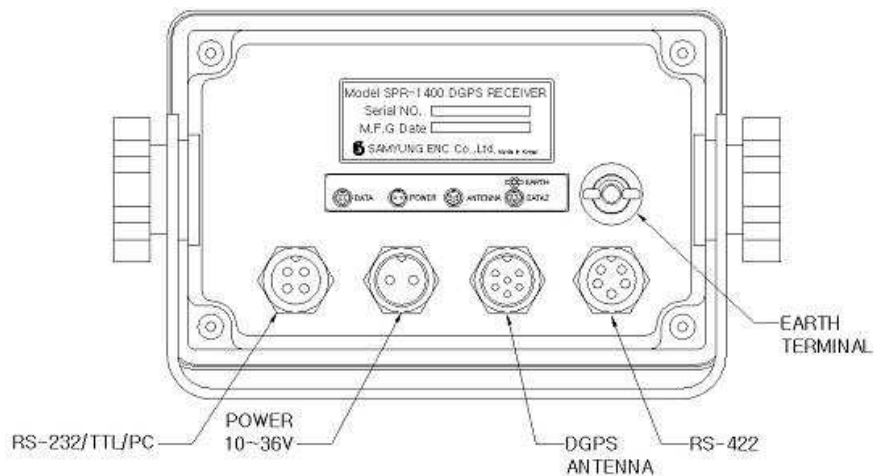

CHAPTER 5. OPERATION

5.1 FUNCTIONS

Power on/off and adjusting illumination

ON/OFF

- * Press this key more than 1sec : On
- * Press this key more than 2sec : Off
- * When the power is on, press this key less than 1 sec.
: Adjusting illumination

1. Operation of navigation

1) Registration of way point or mark

MENU → **NAVIGATE** → **ENT** → **WP/MARK CREATE/VIEW** → **ENT** → **▲, ▼** → **ENT**

- * Input WAYPOINT name, WAYPOINT number, Kind of Mark, Longitude and Latitude.

- **LOG** → **ENT** : Input
- **Exit** → **ENT** : Cancellation input
- **MENU** : Cancellation input

```

- WAYPOINTS CREATE -
NAME      : WPT-001
NUMBER    : 001  MARK/MOB : +
LAT       : 35° 04.974' N
LON      : 29° 04.399' E
Exit [MENU] LOG [ENT]

```

<Input waypoints or mark>

2) Registration of MOB (Man overboard)

MENU → **NAVIGATE** → **ENT** → **WPT/MARKCREATE/VIEW** → **ENT** → **▲, ▼** → **ENT**

- * Select "⚓" in <Mark Create>.

- * Input(or correct) Name
(the next spot of "MOB "), number,
longitude and latitude.

- **LOG** → **ENT** : Input
- **Exit** → **ENT** : Cancellation input
- **MENU** : Cancellation input

```

- WAYPOINTS CREATE -
NAME      : WPT-001
NUMBER    : 001  MARK/MOB : ⚓
LAT       : 35° 04.974' N
LON      : 29° 04.399' E
Exit [MENU] LOG [ENT]

```

<Registration of MOB>

3) Registration of ROUTES

(MENU) → (NAVIGATE) → (ENT) → (NAVIGATE) → (ENT) → (▲, ▼) → (ENT)

* Input waypoint number starting route name, number in order.

- (LOG) → (ENT) : Input
- (Exit) → (ENT) : Cancellation input
- (MENU) : Cancellation input

-- ROUTES CREATE --			
NAME :	RUT-01	NO.01	
01	WPT-001	+ 001	
02			
03			
04			
Exit [MENU] LOG [ENT]			

<Registration of route>

4) Selection of Next Way Point

(MENU) → (NAVIGATE) → (ENT) → (NAVIGATE) → (NEXT WAYPOINT Select) → (ENT)

→ (▲, ▼) (WAYPOINT number) selection

- (ENT) → (MENU) : Input
- (MENU) → (MENU) : Cancellation input

WPTS / MRKS LIST					
01	01	001	WPT-001		+
01	02	002	WPT-002		x
--	--	003	WPT-003		o
--	--	004	WPT-004		□
01	03	005	WPT-005		*
--	--	006	WPT-006		^

<Next Waypoints>

5) Selection of Next Route

(MENU) → (NAVIGATE) → (ENT) → (NAVIGATE) → (NEXT ROUTES Select) → (ENT)

→ (▲, ▼) (Select ROUTES number) → (ENT)

→ (▲, ▼) (Select WAYPOINT number)

- (ENT) → (MENU) : Input
- (MENU) → (MENU) : Cancellation input

ROUTES LIST		
01	RUT-01	04
02	RUT-02	07
03	RUT-03	12
04	RUT-04	05
05	RUT-05	07
06	RUT-06	20

<Next Route>

2. Calculate distance, direction, time

1) Calculate from own ship to Way point.

(MENU) → [DIRECTION] <CALCULATE> → [ENT]

* Mode Selection : → [DIRECTION] <MODE:WAYPOINTS>

→ [ENT]

* Selection of starting point :

→ [DIRECTION] <FORM:SHIP> → [ENT]

* Selection of the place to be calculated :

→ [DIRECTION] <TO:xxxxxxx> → [ENT] → [DIRECTION] <Selection of WAYPOINTS> → [ENT]

* Enter Speed of the vessel : → [DIRECTION] <SPD:AUTO> → [ENT]

* Display calculated TTG, ETA, RNG, BRG.

(MENU) : Back to the main menu.

```

-- CALCULATION --
MODE:WAYPOINT
FROM:SHIP
TO:001
SPD:AUTO      12.6kt
TTG:          ETA:
RNG:000.2nm  BRG:002
    
```

<Calculate ROUTES>

2) Calculating Between two WAY POINT

From Above "1" Starting point, select "FORM: WAYPOINTS".

3) Calculating ROUTES

(MENU) → [DIRECTION] <CALCULATION> → [ENT]

* Mode Selection : → [DIRECTION] <MODE:ROUTE>

→ [ENT]

* Routes Selection : → [DIRECTION] <ROUTES number>

→ [ENT]

```

-- CALCULATION --
MODE:ROUTE      (R=01)
FROM:01         (W=001)
TO:02           (W=002)
SPD:AUTO      12.6kt
TTG:          ETA:
RNG:000.0nm  BRG:002'
    
```

<Calculate ROUTES>

* Selection starting point :

→ [DIRECTION] <FORM:> → [ENT] → [DIRECTION] <WAYPOINTS number> → [ENT]

* Selection of the place to be calculated :

→ [DIRECTION] <TO:> → [ENT] → [DIRECTION] <WAYPOINTS No> → [ENT]

* Enter Speed of the vessel : → [ENT] → [DIRECTION] <SPD:AUTO> → [ENT]

Warning) : If you had selected "MENU", then input own ship's speed.

* It calculates and indicates TTG, ETA, RNG, BRG from selected point (FORM) to the point (TO)

(MENU) : Go back to the Main menu.

```

-- ALARMS SETUP --
BUZZER : Short
ARRIVAL: Off      0.10nm
ANCHOR  : Off      0.10nm
XTE     : Off      0.10nm
SPEED   : Off      10.0kt
TRIP    : Off      100nm
    
```

3. Alarm Setup

1) How to select



* Select wanted item: → ENT → ▲, ▼

-- ALARMS SETUP --			
BUZZER	:	Short	
ARRIVAL	:	Off	0.10nm
ANCHOR	:	Off	0.10nm
XTE	:	Off	0.10nm
SPEED	:	Off	10.0kt
TRIP	:	Off	100nm

<Alarm setup>

* Change it.

* After all change or partly change is completed, go to → MENU : After inputting, Exit

2) Range of selection

* BUZZER (Type of the alarm): SHORT, LONG, CONSTANT

* ARV/ANC (Alarm of the arrival & Anchor): Arrival/Anchor & 0.00 - 9.99nm

* XTE (alarm of the course secession): on/off & 0.00 - 9.99nm

* SPEED: OFF/BELOW(LOW SPEED)/Over(HIGH) & 00.0 - 99.9kt

* TIME: OFF/ON & 00:00 - 23:59

* TRIP (Alarm of trip distance): OFF/ON & 000~999nm

3) How to set up Input Voltage

Press **ON/OFF** key for more than 1 sec until ON appears,

then press and hold up MENU ,
the setup screen comes up.

-- Powr Alam Set --			
10.0V	---	14.0v	.
20.0V	--:	ff	0.10nm
User	---	Setting	
	10.0	--	36.0

After finishing setup using ▲, ▼ at the wanted position to change, press ENT button.

4. Output and Input of the data(I/O)

1) Output of the data (Storage in external memory)

(MENU) → (I/O SETUP) → (ENT) → (SAVE WP/RUT) → (ENT)

* ▲,▼(After selecting WP DATA or RUT DATA) → (ENT) : After output, exit.

(MENU) : After cancellation, exit

* DATA of WAYPOINT, MARK, MOB, ROUTES, be output from personal computer connected with external RS-232C.

2) Input of the data from external memory

(MENU) → (I/O SETUP) → (ENT) → (LOAD WP/RUT) → (ENT)

* ▲,▼(After selecting WP DATA or RUT DATA) → (ENT) : After input, exit.

(MENU) : After cancellation, exit.

* DATA of WAYPOINT, MARK, MOB, ROUTES, be input from personal computer connected with external RS-232C.

3) Set up input data

(MENU) → (I/O SETUP) → (ENT) → (INPUT DATA) → (ENT)

▲,▼(Select one between INTERNAL or EXTERNAL.) → (ENT) : After setup, exit.

* INTERNAL is from internal GPS receiver, EXTERNAL is from external GPS.

4) Set up OUT FORMAT

(MENU) → (I/O SETUP) → (ENT) → (OUT FORMAT) → (ENT)

▲,▼(select one among NMEA VER1.5, NMEA VER2.0, FURUNO CIF.)

→ (ENT) : After setup, exit.

5) External input/output test

◀+▶ → (MENU) → (I/O SETUP) → (ENT)

Press (ENT) on SYSTEM TEST for external input test. (Short of output/input)

```

-- SYSTEM TEST --
EXT-PORT: Good ...

```

5. Set up system

1) Set up Coordinate

- * Select range : **WGS84**, WGS72, KOREA/TOKYO, NORTH AMER1927,
EUROPEAN 1950, AUSTRALIAN 1984, ADIADAN, ETC.
SET(selectable from 001 to 171)

(MENU) → (◀▶) <SYS SETUP> → (ENT) → (◀▶) <DATUM> → (ENT) → ▲, ▼ → (ENT)

2) Set up Unit

- * Select range : **nm/kt**, mm/mh; km/kh

(MENU) → (◀▶) <SYS SETUP> → (ENT) → (◀▶) <UNIT> → (ENT) → ▲, ▼ → (ENT)

3) Set up Time Difference

- * Select Mode : +13:30~-13:30

(MENU) → (◀▶) <SYS SETUP> → (ENT) → (◀▶) <TIME DIFF> → (ENT) → ▲, ▼ → (ENT)

4) Set up Time display Mode

- * Select range : 12 hours, 24 hours

(MENU) → (◀▶) <SYS SETUP> → (ENT) → (◀▶) <TIME DISP> → (ENT) → ▲, ▼ → (ENT)

5.2 Description of FRONT BOARD

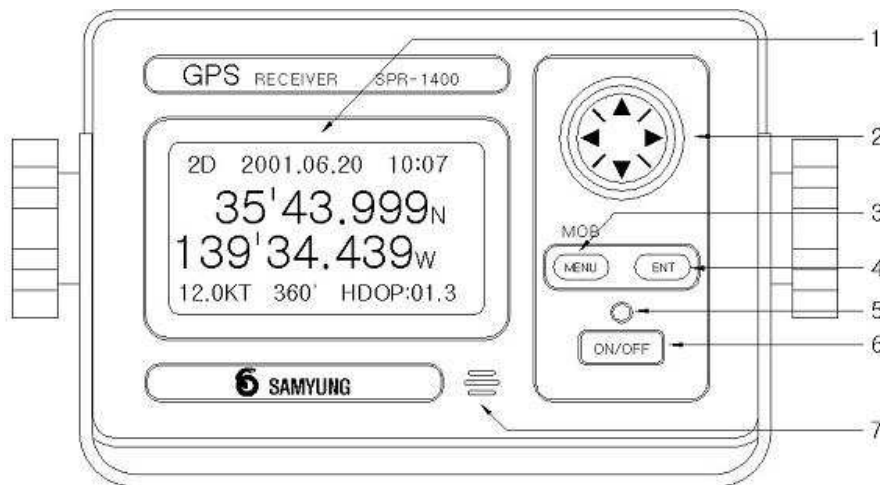

1. Front LCD

It displays wide range of information. According to display mode (ENT) switch pressed, it displays 6 kinds of GPS screen and various menu screen.

Display unit is displayed with set UNIT (Set in SYS SETUP Menu) for both (nm/kt, nm/mh or km/h) and 24hours or 12hours displaying methods.

2. (Direction key)

Use as a switch for choosing item in Menu screen or choosing setting value.

(▲, ▼ switch in Main display screen can be adjusting brightness of LCD letter)

3.

It plays as a MENU selecting switch, but in case Menu screen presently being selected, it activates as a return switch to previous screen.

4.

To input setting value or function set in MENU screen. It also works as 6 kinds of selection switch for information display screen when screen is for 6 kinds of information display mode not in Menu screen.

5. LED

When the unit is working properly, LED light comes up.

6. Switch

As a switch for Power supply and light adjusting.

* For power supply on : press  switch for 1 second.

- * For power supply off : press switch for 2 seconds.
- * For adjusting LCD light and switch Dimmer : press switch one second.
Note) If pressed over 2 second, power will be off.

7. Buzzer

When switch on, beep and alarm comes out.

5.3 DISPLAY SELECTION

1. When pressed (ENT) switch, screen will be changed as follows.

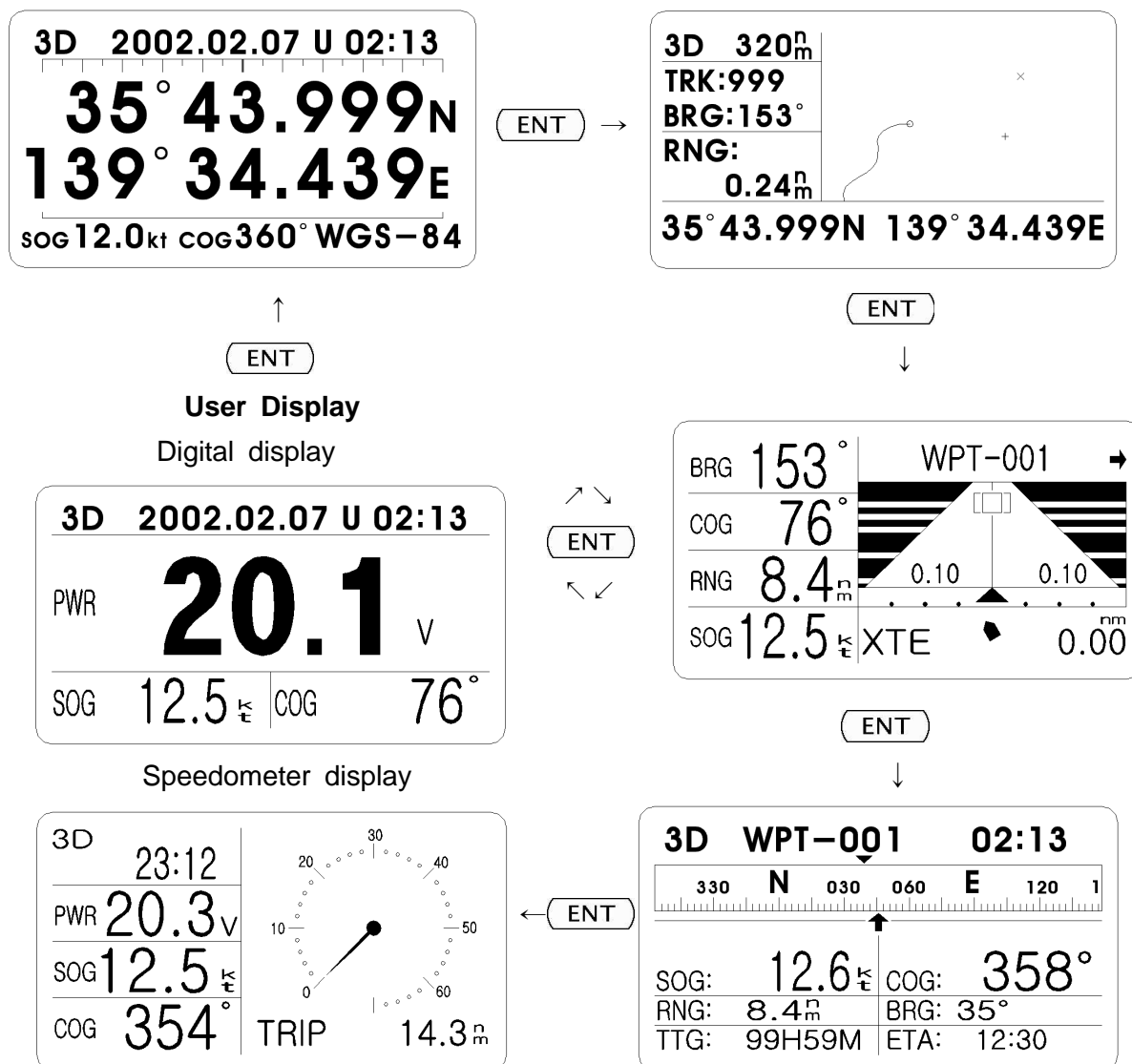

2. When (MENU) is pressed in plotter screen, it is changed to plotter menu screen and changed to main menu screen from other screen.

When (MENU) is pressed in Plotter MENU, it will go back to MAIN MENU.

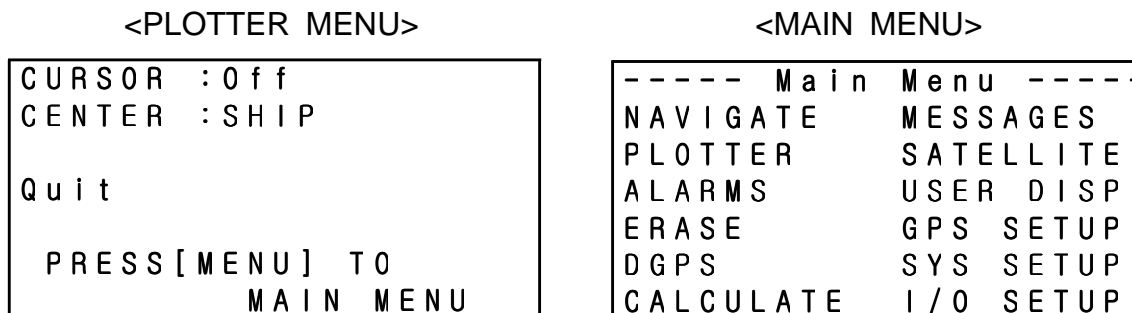

5.4 Description of navigator screen

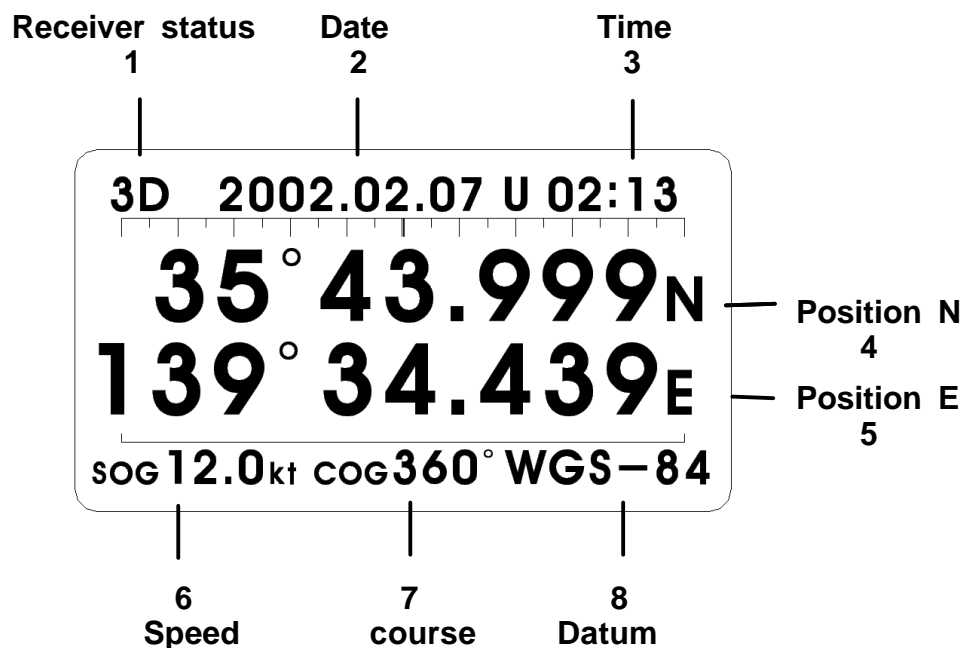

1. Receiver status (3D)

GPS Receiving Status : (" /"DR"/"2D"/"3D"/"WAAS"/"DGPS"/"GPS"/"SIM") "3D" shown at the top of the left side will be displayed "DR" when satellite is not being selected, while it displayed "2D" when the satellite is selected and 2 dimension determination is processing. When the 3 dimension determination is processed, it displays "3D". When it is not identified whether status is "2D" or "3D", or from outside input, it displays "DR". When it is in the process of receiving DGPS, it displays DGPS.

* When it is working with simulator, "SIM" is flickering at this place.

* Displayed "WAAS" in case of receiving WAAS signal.

2. Date(2002.02.07)

It represents the present year, month and day.

3. Time(02:13)

Available to display 24 hours type (10:07 16) or 12 hours type (10:07AM).

If time is not accurate, number is flickering. When "U" is displayed in front of time, it means UTC time, and in case of "L", it means Local time.

4. Latitude (35'43.999N)

Ship's latitude : latitude at ship's location.

5. Longitude (139'34.439E)

Ship's longitude : longitude at ship's location.

6. Speed(SOG 12.0kt)

Ship's speed : The existing ship's moving speed which is relative against the land.

7. Course(COG 360')

Ship's direction : Ship's moving direction which is relative direction against the land.

8. Datum(WGS-84)

Datum : It displays presently using DATUM. If is set up by external data, it displays "EXTERN".

5.5 PLOTTER SCREEN DISPLAY AND FUNCTION

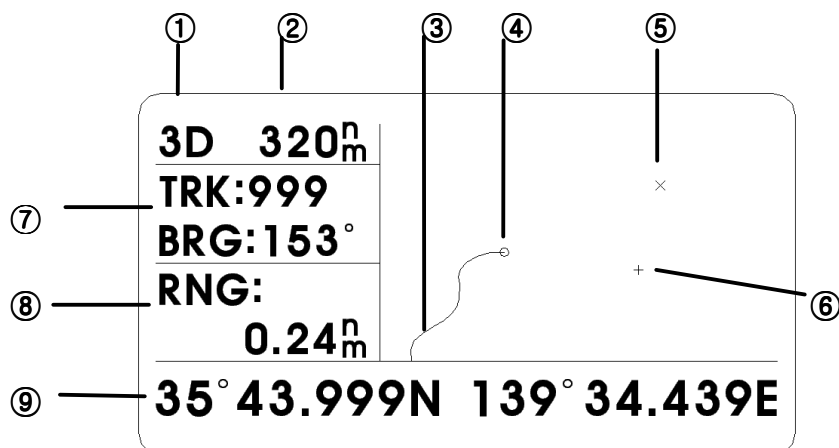

1. Description on display

① Receiver status(3D)

GPS receiver status : it represents " ", "DR", "2D", "3D", "DGPS", "GPS", "SIM".

* When it is working with simulator, "SIM" is flickering at this place.

② Horizontal display range setting (320nm)

It represents distance of horizontal width on the plotting screen.

It can set up 0.02, 0.05, 0.1, 0.2, 0.5, 1, 2, 5, 10, 20, 40, 80, 160, 320nm by adjusting direction switch like ◀(distance to be narrow), ▶(distance to be wide) without curse coming on the screen.

③ Boat's track(-)

It displays ship's track as a line (hereinafter called ship's track).

When it displays on the existing screen, it displays as much details as possible, but when it calls the change of screen or memorized ship's track, it shows according to ship's track memory distance (Distance is set at Menu.)

④ Own ship mark (o blinking) : It displays ship's existing position as a dot.

⑤ Waypoint mark(x Shape selectable) : it displays destination as a registered mark.

⑥ Cursor(+) : It displays cursor as "+" which functioned ON/OFF at menu screen.

⑦ TRK: -> Track Point(TRK ; 990)

It displays total track points so far recorded.

BRG: -> Bearing to cursor or Bearing to Course (BRG: 130°)

It displays direction for destination from existing position. When it displays "RNG:+", it means cursor position from the existing position.

⑧ Range to cursor or Range to Course (RNG:+ 8.4nm)

When "RNG:+8.4nm" comes on indicator, it means displayed distance for cursor point from the existing position.

⑨ Cursor position(35° 05.221 N 129° 04.180E)

When it displays cursor(+) on the indicator, it displays cursor's position, but when it is without cursor, it displays own vessel's position.

2. Setting-up the function

- 1) When menu switch is pressed on the plotter screen, menu screen for setting up the function comes up and being displayed as follows.
- 2) Press the direction switch on plotter menu screen for selected position with changing to letter mode and press the "ENT" switch for selection.
- 3) After changing to "Quit" letter on the indicator, press the "ENT" switch then it returns to plotter screen.
- 4) Press "MENU" switch on the plotter screen, it reansformed to MAIN MENU.

<PLOTTER MENU>

<MAIN MENU>

C U R S O R : O f f
C E N T E R : S H I P
Q u i t
P R E S S [M E N U] T O
M A I N M E N U

----- MAIN MENU -----	
NAVIGATE	MESSAGES
PLOTTER	SATELLITE
ALARMS	USER DISP
ERASE	GPS SETUP
DGPS	SYS SETUP
CALCULATE	I/O SETUP

5) Select CURSOR(ON/OFF)

It is function of setting-up whether it displays course on the plotter screen or not. When cursor is displayed, it also displays the value of course position like the distance from the vessel position to course.

When the cursor is not displayed on the screen, it displays the value of the existing ship's position and the distance from the ship to waypoint, and when press the "◀" switch, screen magnification ratio becomes reduced and when press the "▶" switch, screen magnification ratio becomes increased.

When the cursor is on, if you move it : Central point of display will be changed as the spot of cursor.

6) Select CENTER(SHIP/CURSOR/OFF)

Select the center of plotter screen as the ship's existing position or cursor position. Once selected, it automatically goes off.

* On plotter screen not selected center line with its cursor on.

Cursor position is on the center of screen(going out of the screen) when cursor is off, ship's position would be automatically the center of screen(time about going out of the screen).

5.6 HIGHWAY SCREEN SETTING

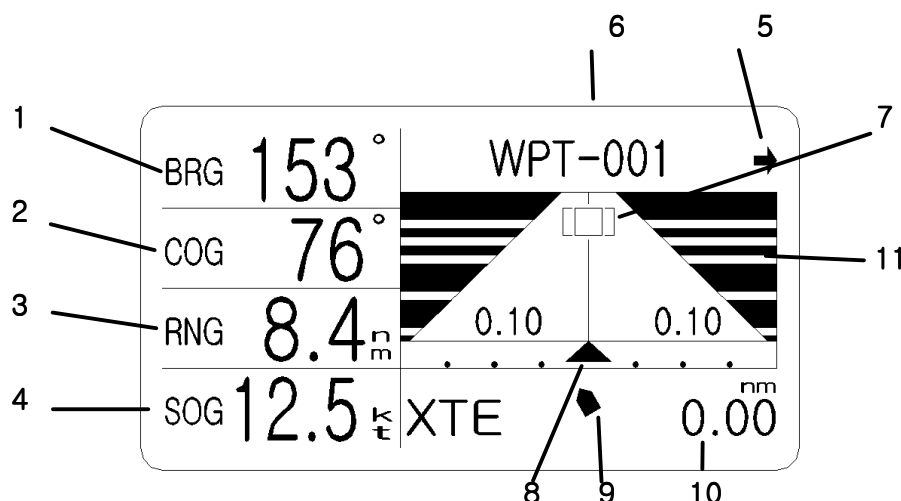

1. Bearing from own ship to destination waypoint (BRG 153°)

It displays direction towards destination from the present position.

* When it is working with simulator, "SIM" is flickering at this place.

2. Course(COG 76°) :It displays ship's moving direction.

3. Range from own ship to destination waypoint (RNG 8.4nm)

It displays distance from the present position to destination.

4. Speed(SOG 12.5kt) : It displays ship's moving speed.

5. Direction to steer(to return to course), (▶)

It displays when the present ship's direction differs from destination waypoint.

In order to go destination waypoint, display steering direction to right or left by arrow mark(◀ or ▶).

6. Destination waypoint name(WPT-001)

It displays waypoint name and designates name at MENU

7. Destination waypoint([□]) : It displays MARK of next destination waypoint

8. Analog XTE(Cross-track error) scale

When the ship is course off, difference is displayed to ▲ on analogue scale. If the waypoint is not set up, ▲ mark is displayed to "N" (Nautical position).

9. Δ (Delta Course)

When destination waypoint was not set up, the ship's direction is displayed to arrow at North up Mode(topside is North, downward is South). If it sets up waypoint, it displays the ongoing direction of ship's direction.

10. Digital XTE indication(0.00nm)

When the ship is the course off, distance is displayed to arabic number.
(aforesaid clause 8, Analogue is displayed to Digital)

11. According to speed of ship's direction, it differs from moving speed on the display.

5.7 STEERING SCREEN

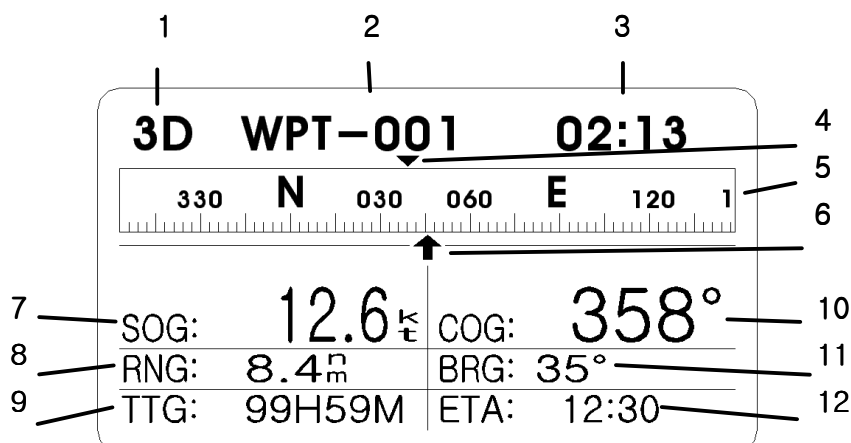

- 1. Receiver status(3D)** : When the status is on the GPS receiving
It displays "DR", "2D", "3D", "DGPS", "GPS", "SIM" under the GPS receiving condition
* When it is working as a simulator, "SHIM" is flickering at the place
* **When it is receiving "WASS" signal. it displays "WASS".**
- 2. Destination waypoint name (WPT-001)** : It displays the name of next waypoint, and designates its name on MENU
- 3. Time (02:13)** : It displays the present time.(Ex. 21:34 or 09:34P)
- 4. Bearing from own ship to destination (▼)** :
It displays direction (▼) towards destination from the present position.
e.g) In case that present position is 345' and destination from the present position is +66', the position of analogue direction marked scale 354' will be placed upper center arrow mark(↑) and the destination waypoints mark (▼) will be displayed on 60' of Analogue direction scale.
- 5. Bearing scale (Analogue scale)** : The center position of the scale is displayed with +90' (Right) and -90'(Left) by scale and digit from the point of own vessel's bearing.
- 6. Own ship mark (↑)** : The Arrow mark will be displayed on the center of analogue screen, and position value of analogue style scale will be displayed as present ship's position.
- 7. Speed (SOG 12.6kt)** : It displayed ship's moving speed
- 8. Range from own ship to destination (RNG 8.4nm)** : It displays distance from the present position to the destination.

9. Time-To-Go(TTG 99H59) : It displays that arrival time shows max.99hr.59min.

10. Course(COG 358°) : It displays ship's moving direction.

11. Bearing (BRG 35°) : It displays the direction of destination.

12. Estimated Time to Arrival at destination(ETA 12:30) : It displays the estimated arrival time at destination

5.8 USER DISPLAY

It, user display, displays the selected screen by user either digital display screen or speedometer screen, and the parts of contents(3 items out of SOG, COG, RNG, BRG, TTG, ETA, TRIP, PWR) being displayed on the screen can be set up by user.

1. Speedometer Display

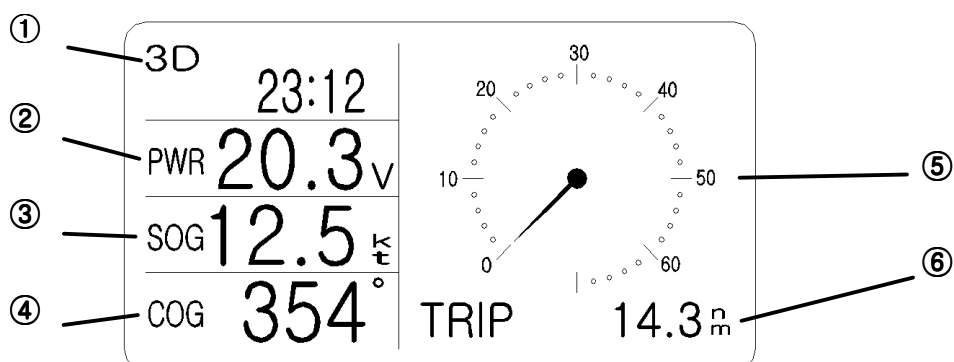

① : Receiver status(3D) and Time(23:12)

It displays GPS receiving status(" ", "DR", "2D", "3D", "DGPS", "GPS", "SIM") and the present time. (This item can not be selectable)

* When it is working as simulator, "SHIM" is flickering at this place.

② : It displays by user after selection out of SOG, COG, RNG, BRG, TTG, ETA, TRIP, PWR

③ : It displays by user after selection out of SOG, COG, RNG, BRG, TTG, ETA, TRIP, PWR

④ : It displays by user after selection out of SOG, COG, RNG, BRG, TTG, ETA, TRIP, PWR

⑤ : Speedometer (Analog type meter)

It displays ship's moving speed with bar type scale on the analogue type round scale meter. (This item can not be selected)

⑥ : Trip Distance

It displays a navigation distance by number. (This item can not be selected)

2. Digital Display



① : Receiver status(3D) & Date(2002.02.07) and Time(U 02:13)

It displays GPS receiving status (" ", "DR", "2D", "3D", "DGPS", "GPS", "SIM") and the present date(year, month, day) and Time with either 24 hours system and 12 hours system.

* When it is working with simulator, "SHIM" is flickering at the left side of this place.

② : It displays by user after selection out of SOG,COG,RNG,BRG,TTG,ETA,TRIP,PWR.

③ : It displays by user after selection out of SOG,COG,RNG,BRG,TTG,ETA,TRIP,PWR.

④ : It displays by user after selection out of SOG,COG,RNG,BRG,TTG,ETA,TRIP,PWR.

3. User setting item

A. SOG(Speed) : It displays ship's moving speed.

B. COG(Course) : It displays ship's moving direction.

C. RNG(Range from own ship to destination) : It displays distance form the present position to the destination.

D. BRG(Bearing from own ship to destination waypoint) : it displays direction form the present position to the destination.

E. TTG(Time-To-Go) : It displays time required to the destination with max.99hrs 59min.

F. ETA(Estimated Time of Arrival at destination) : It displays the estimated time of arrival at destination.

G. TRIP(Trip Distance) : It displays navigation distance.

H. PWR(Power) : It displays input power.

5.9 MENU

After pressed **(MENU)** switch on the front of machine, the following pictures are displayed on Main Menu screen. The present selected item of which letter are displayed up and down. After selected item with ▲(top), ▼(down), ◀(left), ▶(right) switch and press the **(ENT)** switch, then sub menu will be displayed.

When **(MENU)** switch is pressed in the main menu screen, it will return to Main display screen (the screen just before changing to MENU screen such as Plotter screen or Navigator screen)

MAIN MENU

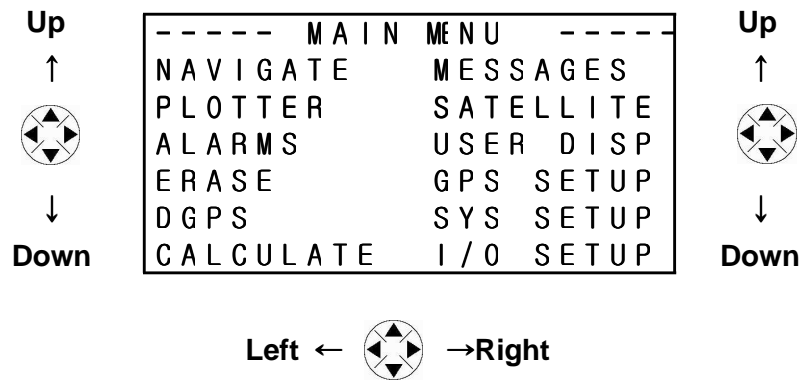

5.10 MENU STRUCTURE & INITIAL SETTING VALUE

MENU	PLOTTER DISPLAY MODE	CURSOR(ON, OFF), CENTER(SHIP, CURSOR, OFF)
	NAVIGATE	WPT/MARK Create/View -> Waypoint or Mark creation & List ROUTES Create -> Routes & List NEXT WAYPOINT Select NEXT ROUTES Select ANCHORAGE Select NAVIGATION Cancel
	PLOTTER	TRACK REC(OFF, DISTANCE, TIME) INTERVAL(30sec)->Set up the route record interval BRG. REF (MAG, TRUE) MAG.VAR (AUTO ,MANUAL) WYPT MARK (DSP GOTO ,DSP ALL) RESET TRIP
	ALARMS	BUZZER(SHORT ,LONG,CONSTANT)- ARRIVAL(OFF ,ON/ 0.10nm) ANCHOR(OFF ,ON/ 0.10nm) XTE(OFF ,ON/ 0.10nm) SPEED(OFF ,BELOW,OVER/ 10.0kt)- TRIP(OFF ,ON/ 100nm)
	ERASE	WAYPOINTS/MARKS ROUTES TRACK MENU SETTINGS ERASE ALL
	CALCULATE	MODE(WAYPOINT ,ROUTE),SPD(AUTO ,MANUAL) FROM(SHIP ,WAYPOINT)
	DGPS	MODE(AUTO ,MANU) FREQUENCY(280.0KHz) SPEED(25,50, 100bps ,200)
	MESSAGES	
	SATELLITE	
	USER DISP	USER DISP(DIGITAL, SPDOMETER)-> LARGE/TOP(SOG ,COG,TTG,ETA,RNG,TRIP,BRG,PWR) LEFT/MIDDLE(SOG, COG ,TTG,ETA,RNG,TRIP,BRG,PWR) RIGHT/LOWER(SOG,COG,TTG,ETA, RNG ,TRIP,BRG,PWR)
	GPS SETUP	SMOOTH POS(0~999 SEC, 0 SEC) SMOOTH S/C(0~999 SEC, 10/10 SEC) AVR.SPEED(0~99 MIN, 99 MIN) LAT OFFSET(+00.00) LON OFFSET(+00.00) FIX MODE(2D/, 2/3D)For 2D,default antenna height is 5m
	SYS SETUP	DST-CALE (Great Circle, Rhumb Line) DATUM(WGS84 , WGS72, KOREA/TOKYO, NORTHMER1927, EUROPEAN1950, AUSTRALIAN 1984, ADIADAN,ETC. SET(No.001~171)- UNITS(nm/kt , km/kh; mm/mh) TIME DIFF(+00:00) TIME DISP(12HOUR, 24HOUR) SIMULATOR(off ,low,mid,high)
	I/O SETUP	INPUT DATA(INTERNAL ,EXTERNAL) OUT FORMAT(NMEA V1.5, NMEA V2.0 ,FURUNO CIF) SAVE WP/RUT LOAD WP/RUT

6. HOW TO SET-UP & PROCESS

6.1 NAVIGATION

Select "NAVIGATE" on the **(MENU)**, following screen will be displayed;

Available to set up waypoints, mark & route, and to see contents, compile and assign next route on the "NAVIGATE" menu

After changing letter of the wanted item with direction switch, press **(ENT)** to see the sub-menu

```

----- NAVIGATE -----
WPT / MARK      Create / View
ROUTES          Create / View
NEXT WAYPOINT   Select
NEXT ROUTES     Select
ANCHORAGE       Select
NAVIGATION      Cancel
    
```

<NAVIGATE Main Menu>

1. WAYPOINTS, MARK, MOB setup

Select WPT/MARK Create/View, then list screen will be shown up as follows and press "ENT" switch at the wanted position (creation number), then creation screen will be shown up.

```

WPTS / MRKS LIST
01 01 001 WPT-001 +
01 02 002 WPT-002 x
-- -- 003 WPT-003 o
-- -- 004 WPT-004 □
01 03 005 WPT-005 *
-- -- 006 WPT-006 ^
    
```

<WAYPOINTS/MARK LIST >

```

-WAYPOINTS CREATE-
NAME : WPT-001
NUMBER: 001 MARK / MOB : +
LAT : 35° 04.974' N
LON : 129° 04.399' E
Exit [MENU] LOG [ENT]
    
```

<WAYPOINTS/MARK setup>

1) For latitude and Longitude information, it is a plotter screen before selecting waypoints set up screen, while the cursor is being displayed, cursor position is set up as a initial setting value and own vessels current position will be set up in other screen mode.

2) NAME Setup

* Press direction button to reverse the letter of NAME and press "ENT" switch, then the wanted letter is flickering to get ready to input the letter by using direction switch ◀, ▶, ▲, ▼, and press "ENT". Press "MENU" switch after selecting all the wanted letters, then it goes back to previous screen.

* In case of selecting MOB from "MARK/MOB", the front 4 letters is fixed to "MOB". Therefore, it is available to change last 4 letters among 8 letters in NAME.

3) NUMBER Setup

* Press direction button to reverse the letter of NUMBER, and press "ENT".

Available to input the figures(000-999) by selecting the position of figure & figures by direction button ◀, ▶, ▲, ▼ and press "ENT".

4) Select MARK/MOB

* Press direction button to reverse MARK/MOB letter, press "ENT" and select the kind of MARK by direction button(▲, ▼)

* If selecting ⚓ as a Mark, it will be MOB(Man overboard), available to change the front 4 letters among 8 letters. The 4 letters are fixed to MOB.

* The kinds of "MARK" selectable are as follows.



5) Input Latitude(LAT)

* Press direction button to reverse LAT letter, press "ENT". Select the location & letter by direction button(◀,▶,▲,▼), press "ENT" for setup.

6) Input Longitude(LON)

* Press direction button to reverse LON letter, press"ENT".
Select the location & letter by direction button(◀,▶,▲,▼), press "ENT" for setup.

7) After all setup completed, have the letter of "LOG " reversed and "ENT".
And press "MENU" button or have the letter of "EXIT" reversed by direction button, it goes back to main screen.

(Caution !!) If pressed "MENU" button or press "ENT" after selecting "EXIT", then it returns main screen without saving current information.
Therefore it must be noted that before pressing "ENT" button, select "LOG" and press "ENT".

2. WAYPOINTS, MARK, MOB

If selecting WPT/MARK Create/View, the screen of LIST will be shown up.

1) It will be shown up 6 lines at one time
If selecting ▲(Up), ▼(Down), available to see all information.

	W	P	T	S	/	M	R	K	S	L	I	S	T	
0	1	0	1	0	0	1	W	P	T	-	0	0	1	+
0	1	0	2	0	0	2	W	P	T	-	0	0	2	x
-	-	-	-	0	0	3	W	P	T	-	0	0	3	o
-	-	-	-	0	0	4	W	P	T	-	0	0	4	□
0	1	0	3	0	0	5	W	P	T	-	0	0	5	*
-	-	-	-	0	0	6	W	P	T	-	0	0	6	^

|

|

|

|

|

①
②
③
④
⑤

2) If pressed "MENU" button on the screen-"WPTS/MARKS LIST", it returns previous screen. From here press "ENT" button on the screen-"WPTS/MARKS LIST".to make it avail to modify setup information.

3) Contents those are displayed as follows:

- ① "ROUTE NO"(It displays appropriate ROUTES number when it is set up as a destination at the ROUTES NAVIGATION)
- ② "COURSE NO"(Set up destination at the ROUTES NAVIGATION)
- ③ WAYPOINTS NO(Assigned at the setup screen, displayed in a number order)
- ④ WAYPOINTS NAME(Assigned at the setup screen)
- ⑤ MARK (Assigned at the setup screen)

3. ROUTES setup

Select ROUTES Create/View, screen of ROUTES LIST will be appeared, and if pressed "ENT" at the position where is available to modify or setup, setup screen will show up.

R O U T E S L I S T		
0 1	R U T - 0 1	0 4
0 2	R U T - 0 2	0 7
0 3	R U T - 0 3	1 2
0 4	R U T - 0 4	0 5
0 5	R U T - 0 5	0 7
0 6	R U T - 0 6	2 0

<ROUTERS LIST Screen >

-- R O U T E S C R E A T E --		
N A M E :	R U T - 0 1	N O . 0 1
0 1	W P T - 0 0 1	+ 0 0 1
0 2		
0 3		
0 4		
E x i t [M E N U] L O G [E N T]		

<ROUTERS setup screen>

1) NAME setup

* Press direction button to reverse NAME letter, press "ENT", then the screen for letter selection will come up and the wanted letter will be flickering. Press "ENT" after selecting the wanted letter by direction switch. Press "MENU" switch after selecting all the letters, then it goes back to Setup Screen.

2) NUMBER setup

* Press direction button to reverse NUMBER letter, and press "ENT" with selecting the figure's position and figure (01-50) by direction button(◀,▶,▲,▼), and press "ENT".

3) Setup Waypoints

* After pressing direction button to reverse the wanted waypoints number, press "ENT" to show up the screen of WAYPOINTS LIST.

Have a waypoints number reversed by direction button(▲,▼), press "ENT".

4) Modification or Deletion Waypoints

* After reversing waypoints number already setup, press "ENT", then it is shown up with "Erase WPT? & "YES NO". Choose "YES" and press "ENT" for the cancellation of waypoints. If you choose "NO", available to set up waypoints again.

5) After all setup, make a "LOG" converse and press "ENT". It will be saved the setup information on setup location.

Press "MENU" button or make a "EXIT" letter by direction button. It will be back the main screen.

Assign setup waypoints name or waypoints No. and available to set up route starting, route progress and final destination for selecting destination.

To set up waypoints or waypoints No. Make a converse the setup location of waypoints name and No. and press "ENT". Move to the location of letter by ◀(Up), ▶(Right) and select letter by ▲(Up), ▼(Down) and set up waypoints name and No.

Note) If selecting "MENU" or "EXIT" and press "ENT", it will be back a main screen without saving current information, select "LOG" and press "ENT".

4. Routes Contents Display

Select "ROUTE LIST", following screen appears :

1) It shows up 6 lines one time.
If selecting ▲(up),▼(down) switch, available to see all information.

R O U T E S L I S T		
0 1	R U T - 0 1	0 4
0 2	R U T - 0 2	0 7
0 3	R U T - 0 3	1 2
0 4	R U T - 0 4	0 5
0 5	R U T - 0 5	0 7
0 6	R U T - 0 6	2 0

①

②

③

2) From this screen, if pressing "MENU", available to see previous screen and if pressing "ENT", it get ready to modify information

3) Displayed contents are as follows

- ① ROUTE No. (Designated at ROUTE creation screen and displayed this number in order)
- ② ROUTE NAME (Designated at ROUTE creation screen)
- ③ Total number of WAYPOINTS (Designated at Create screen)

5. Set up next WAYPOINTS

If select "NEXT WAYPOINTS", following screen will show up:

- 1) It will be shown 6 lines at one time. If pressing ▲(up), ▼(down), available to see all information.
- 2) If pressing **[MENU]**, it goes back to previous screen.
If pressing **[ENT]**, available to modify information.

	W P T S / M R K S	L I S T	
0 1	0 1 0 0 1	W P T - 0 0 1	+
0 1	0 2 0 0 2	W P T - 0 0 2	x
--	-- 0 0 3	W P T - 0 0 3	o
--	-- 0 0 4	W P T - 0 0 4	□
0 1	0 3 0 0 5	W P T - 0 0 5	*
--	-- 0 0 6	W P T - 0 0 6	^

6. Set up next ROUTES

- 1) If select next ROUTES, following screen is shown up;
If selecting **[MENU]**, available to see previous screen. If selecting **[ENT]**, available to modify information.

- 2) Display ROUTE LIST with 6 lines at one time.
Available to see all set up information by ▲(up), ▼(down).

	R O U T E S	L I S T
0 1	R U T - 0 1	0 4
0 2	R U T - 0 2	0 7
0 3	R U T - 0 3	1 2
0 4	R U T - 0 4	0 5
0 5	R U T - 0 5	0 7
0 6	R U T - 0 6	2 0

- 3) If pressing "MENU", it goes back to main screen. If pressing **[ENT]**, it shows as follows
- 4) Display ROUTE NO. with 5 lines at one time. Available to see all set up information by ▲(up), ▼(down).

- -	R O U T E S	C R E A T E	- -
N A M E :	R U T - 0 1	N O .	0 1
0 1	W P T - 0 0 1	+	0 0 1
0 2			
0 3			
0 4			
E x i t	[M E N U]	L O G	[E N T]

- 4) Display a waypoint number in five lines at one time and available to see full registered contents by ▲(up), ▼(down).
- 5) If pressing "MENU", it goes back to main screen. If selecting **[ENT]**, available to assign current route. it will be ROUTES NAVIGATION mode.

7. ANCHORAGE

- 1) Following screen will be shown up if selected ANCHORAGE.
- 2) Put a cursor on the number which will be changed by ◀(L), ▶(R) and set a value by ▲(Up), ▼(Down). Press **[ENT]**, then position of input value is assigned as vessel's anchorage position.
- 3) Press **[MENU]** to return main screen.

8. NAVIGATION Cancel

- 1) If Selected "NAVIGATION", following screen is shown.
If pressed **[ENT]** on "YES", all set navigation is cancelled.
- 2) If pressed **[MENU]** or pressed **[ENT]** on "NO" to return main screen without cancelling set navigation.

6.2 SET-UP PLOTTER

If pressed (MENU) on main screen, it displays MAIN MENU.

After reversing plotter's letter on MAIN MENU screen by , press (ENT) to display PLOTTER SETUP" menu screen as follows;

---- NAVIGATE ----

WPT/MARK Create/View
 ROUTES Create/View
 NEXT WAYPOINT Select
 NEXT ROUTES Select
 ANCHOR
 NAVIGA

1. TRACK REC(How to set waypoint memory)

1) TRACK REC mode is able to set as " OFF", "DISTANCE" and " TIME" and display a current set status.

2) For changing setup, after reversing the current set characters at the "PLOTTER SETUP" screen, and press (ENT), then right screen will show up.

<PLOTTER SETUP >

- - ROUTES CREATE - -
NAME : RUT - 0 1 NO . 0 1
0 1 WPT - 0 0 1 + 0 0 1
0 2
0 3
0 4
Exit [MENU] LOG [ENT]

3) After reversing the letter to be setup by ▲▼ button, press (ENT) to setup and goes back to the above screen.

2. INTERVAL(Setup route memory intervals)

1) INTERVAL setup: According to TRACK REC setup, it setup by distance or time interval and works according to the current status.

2) Let currently set interval value be reversed at "PLOTTER SETUP" screen by  and press (ENT), to select the wanted digit by ▲(up) or ▼(down).

3) The range is selected as follows;
 Distance interval : 0.1, 0.2, 0.5, 1, 3, 5nm
 Time interval : 30 sec, 1, 3, 5, 10, 30 min

3. BRG REF(Setup Base point of Azimuth)

1) To display the azimuth between present position and waypoint, the standard base is TRUE NORTH or Magnetic North. Display as presently set value.

2) Press (ENT) on selected letter, it will change to "MAG" or "TRUE".

4. MAG VAR(Setup error of magnetic north)

1) The errors from own vessel or specific position to true North and Magnetic north depend on each position. To compensate said error, select the way of compensation to "AUTO" or "MANUAL". If selected "MANUAL", compensating value should be set up.

2) Selecting AUTO by (ENT) : It sets up automatically. (Not able to be changed)
 Selecting MANUAL(with (ENT)): User can set up as changeable.

3) In order to change the value, press direction keys to reverse the value.

After pressing (ENT), let the value be flickering by ◀ and ▶.

5. WYPT MARK (WAYPOINT MARK setup)

1) It can set up whether it displays all WAYPOINT MARK or just next destination with DSP GOGO(it displays next destination) or DSP ALL(it displays all destinations)

2) It can be reversed as DSP GOTO or DSP ALL by using direction key, and press (ENT) to set up "DSP GOTO"---->"DSP ALL" or "DSP ALL"---->"DSP GOTO"

6. RESET TRIP(Initial setting for the distance of Route off)

1) It can reset the route off distance. Let the letter of "RESET TRIP" be reversed and press (ENT) to display the letter of "Reset trip?", or YES NO".

Let the letter "YES" be reversed and press (ENT), then contents of TRIP will be erased and goes back to the PLOTTER SETUP screen, and let the letter of "NO" be reversed and press (ENT), it cancels set up function and goes back to PLOTTER SETUP.

6.3 ALARMS SETUP(Set alarm)

If pressed (MENU) on main screen, MAIN MENU will be shown up.

Let the letter of "ALARMS" be reversed on MAIN MENU screen

by ⬇ and press (ENT), then ALARM SETUP MENU screen will be displayed as follows;

Let the letter of wanted item be reversed

on ALARM SETUP screen by direction key and press (ENT)., then it gets ready to change the appropriate item.

- - A L A R M S S E T U P - -		
B U Z Z E R	: S h o r t	
A R R I V A L	: O f f	0 . 1 0 n m
A N C H O R	: O f f	0 . 1 0 n m
X T E	: O f f	0 . 1 0 n m
S P E E D	: O f f	1 0 . 0 k t
T R I P	: O f f	1 0 0 n m

1. BUZZER (Set up the type of BUZZER alert sound)

1) Let the letter of "BUZZER" be reversed by top and bottom ⬇ switch and press (ENT), then SHORT, LONG, CONSTANT will be reversed in turn. Here select one among three kinds as - Short(0.5 sec. interval), Long(About 1 sec. interval) and Constant(Continuity) and press (ENT). to setup.

2. PWR (Input voltage On/Off setup)

1) After reversing "PWR" letter by ⬇ and press (ENT)., then a letter of On/Off is reversed. Select either On(ALARM On) or Off(Alarm Off) and press (ENT) to set up.









2) How to select input voltage setup

Let it be ON status after pressing **ON/OFF** for more than one second. Here press (MENU) to show up setup screen.







Finish a setup on wanted position to change by ⬇ and then press (ENT).

-
- ① 10.0V - 14.0V : For the vessel using 12V battery
 - ② 20.0V - 30.0V : For the vessel using 24V battery
 - ③ User - Setting 10.0V-36.0V : User can set the lowest and the highest voltage.







3. ARRIVAL(Set arrival alarm)

- 1) Let "ARRIVAL" letter be reversed by top and bottom  button and press , then a letter of On/Off is reversed.
- 2) Be changed from On to Off(Or from Off to On) if press . If press  or  (Cancellation On/Off setup), be reversed a number for next destination distance setup.
- 3) Let the wanted position of digit be flickering by left right button , and select the wanted number to change by top and bottom switch , and press  switch to input.







4. ANCHOR

- 1) After reversing the letter of "ANCHOR" by switch top bottom , and press the  switch to reverse ON or OFF.
- 2) Then, when pressing the top bottom switch , it changes ON ->OFF or OFF ->ON and when pressing the button  or MENU (cancel of ON/OFF setup), the digit of next anchor range setup is reversed.
- 3) Let the location of digit to be changed be flickering by right/reft switch , and select the wanted digit by up/down switch  and press . to input.







5. XTE (Set up alarm for Route Off)

- 1) Let the letter of "XTE" be reversed by up/down switch , and press  to reverse the letter of ON or OFF.
- 2) Then, when pressing the switch , it changes ON ->OFF or OFF ->ON and when pressing the button  or MENU (cancel of ON/OFF setup), the number of next course deviation range setup is reversed.
- 3) Let the position of digit to be changed be flickering by right/reft switch , and select the wanted digit by up/down switch , to the button  to input.

6. SPEED (Speed alarm setup)



- 1) Let the letter of "SPEED" be reversed by up/down switch , the letter of OFF/BELOW/OVER is reversed on pressing the button .
- 2) Then, when pressing the top bottom switch , it changes to Off, Below, Over and when pressing the button  or MENU (cancel of Off, Below, Over setup), the number of next limit speed setup is reversed.
- 3) After making the number's location to be changed blink by right/reft switch , after choosing the changeable number by up/down switch , input is O.K on pressing the button .



7. TRIP (Navigation Distance alarm setup)

- 1) Let the letter of "TRIP" be reversed by up/down switch  and press  to reverse the letter of ON/OFF.
- 2) Then, when pressing top down switch , it changes ON ->OFF or OFF ->ON and when pressing the button  or MENU (cancel of ON/OFF setup), the number of next voyage distance setup is reversed.
- 3) Let the position of digit to be changeable be flickering by right/left switch  to select the wanted digit by up/down switch , and input the button . to input.

6.4 ERASE

When you press MENU button in Main Screen, the MAIN MENU appears.

After converting ERASE letter by  button ,
press the button , the display appears like
example in right.



After converting letters by  button
in ERASE MENU DISPLAY, press the button ,
it displays each menu.

```

----- ERASE -----
WAYPOINTS / MARKS
ROUTES
TRACK
MENU SETTINGS
ERASE ALL

```



1) Delete WAYPOINTS/MARKS

After converting WAYPOINT/MARKS by  button, press the button ,

" ALL WPT.MARK ? and "YES NO" will be indicated.



* After converting "Yes", press the button . it deletes WAYPOINTS/MARKS

* After converting "NO", press the button , it shows WAYPOINTS/MARKS.



After converting deleting number by up & down  key and press  button.

It deletes data of WAYPOINTS/MARKS.



2) Delete ROUTES

After converting "ROUTE" letter by  key. Press the button , ALL ROUTE? and
"YES NO" is shown.

After converting "Yes", press  button. It deletes WAYPOINTS and MARKS data stored in
memory.

After converting "NO", press  button. It appears the List of ROUTES data stored in
memory. Then, after converting number to be deleted by  key and press  button. The
data of ROUTES stored in the appropriate number will be deleted.



3) Delete TRACK

After converting "TRACK" letters by  button, press the button , then "Are you sure?"
and "YES NO". is displayed.

* After converting "YES", press the button  to deletes all TRACK data in memory.

* After converting "NO", press the button , it doesn't delete



4) The first stage of MENU SETTING

After converting "MENU SETTING" letters by  button, press the button 
ARE YOU SURE? and "Yes No" is shown.

* After converting "YES", press the button , the setting value sets to the initial value.

* After converting "No", press  button, it cancels "MENU SETTING"

5) DELETE MEMORY

After converting "ERASE ALL" by  button, press  , "Are you sure ?" and "Yes No" is shown.

After converting "YES", press  , it deletes all saved data

After converting "NO", push the button  , it is not canceled. It deletes all saved DATA from MEMORY.

6.5 DGPS

When it uses Beacon Receiver for DGPS, it sets and press (MENU) button, it shows MAIN MENU, after it selects DGPS by (D) button, press (ENT) button and it shows DGPS setting display.

```

-- DGPS SETTING --
MODE           : AUTO
FREQUENCY      : 280.0 KHz
SPEED          : 100   bps

```

<DGPS setting display>

1) Select receiving mode

The receiving mode sets the operation of the Beacon Receiver automatically and manually. But it sets frequency and speed of data in case of speciality.

* After converting "DGPS" by (D) button and press (ENT) button, It is changed to "AUTO", "MANU" and "WAAS".

2) Select frequency

It sets receiving frequency of Beacon Receiver and it is selected regardless of setting frequency in automatic mode.

* After converting "FREQUENCY" by (D) button, press (ENT), it selects setting frequency and shows it

* Let the position of digit to be changed be flickering by right/left (R/L), and press (ENT) to input setting value

3) Select speed

It sets data speed of Beacon Receiver and it is selected regardless of setting speed in automatic mode.

* After converting "SPEED" by (D), push the button (ENT) to display a figure of speed.



* Let the position of digit to be changed be flickering by right/left (R/L), and press (ENT) to input setting value

6.6 CALCULATE (Distance, Bearing, Time Calculation)

It is a function to display after calculating TTG, ETA, RNG, BRG of WAYPOINTS from ROUTE of WAYPOINTS to WAYPOINTS or WAYPOINTS from current vessel position to WAYPOINTS and the letter of CALCULATE is reversed on MAIN MENU and CALCULATION screen is appeared by pressing (ENT) key. This screen for displaying is shown as a final used condition and it is shown with WAYPOINTS MODE in initial stage.

1. Calculate in WAYPOINTS mode

1) MODE :



After selecting "MODE" by  button, press the button (ENT), then "WAYPOINTS" or "ROUTE" is shown. At the same time, it selects WAYPOINTS by up and down  button.



```

-- CALCULATION --
MODE:ROUTE          (R=01)
FROM:01             (W=001)
TO:02               (W=002)
SPD:  AUTO          12.6 kt
TTG:                ETA:
RNG:000.0nm        BRG:002'

```

<WAYPOINTS calculation>

2) FROM : It sets starting position to be calculated, after selecting "FROM" by , push the button (ENT) , choose "SHIP" or "WAYPOINTS" by up and down  button.

3) TO : It sets ending position to be calculated. After selecting "TO" by , press the button (ENT), it shows "WAYPOINTS LIST". It selects "WAYPOINTS" by up and down  button.

4) SPD : It need speed of own ship in order to calculate TTG and ETA from starting point to ending point. If you set this speed, it is available to input by AUTO or MANUAL.



After selecting "SPD" by , press (ENT) button, it changes to AUTO, it inputs speed automatically. But it sets AUTO ,push (ENT) button, the current speed is selected.



* Let the position of digit to be changed be flickering by right/left , and press (ENT) to input setting value

* It sets to the latest average speed under AUTO. latest average speed means averaged speed from AVR SPEED on GPS SETUP MENU.

5) If it inputs the MODE, FROM, TO, SPD, TTG, ETA, RNG, BRG properly, then TTG (Estimated time from to), ETA(Estimated time to destination), RNG (Distance from to) and BRG(Bearing from to) will be displayed after calculation.

2. Calculate time, distance, direction between WAYPOINTS registered in ROUTE.

1) FROM : it sets starting position. After converting the letter of "FROM" by  button and press the button (ENT), ROUTES SELECTS screen is shown, and after selecting waypoint number registered in ROUTE by using top down  button and press (ENT) switch.



- 2) TO : It sets ending position to be calculated.
 After converting "TO" by  button, press the button  to display ROUTES SELECT screen,

```





--      ROUTES SELECT      --
NAME  ROUTE No. 01
0  < ROUTES SELECT > 001
02
03
04
Exit MENU] SET[ENT]

```

<ROUTES SELECT screen>

and selecting WAYPOINTS number registered in ROUTES by using top down  switch and press  switch.

- 3) SPD : It need speed of ship in order to calculate TTG (Estimated navigating time) and ETG(Estimated Arrival time) from starting point to ending point. If you set this speed, it is available to input with AUTO or MANUAL.

After converting "SPD" by  button, and pressing  button, when "MENU" was selected, it changes into AUTO and speed will be input automatically. But when AUTO was selected, press  button to convert the number to be changed, and select the number by top down switch  and press the  switch to input the setting value.

* It sets to the latest average speed under AUTO as the latest on-going average speed ", which means averaged speed from AVR SPEED on GPS SETUP MENU.



- 4) If it inputs the MODE, FROM, TO, SPD, TTG, ETA, RNG, BRG properly, then TTG (Estimated time from to), ETA(Estimated time to destination), RNG (Distance from to) and BRG(Bearing from to) will be displayed after calculation.

6.7 MESSAGES (for Diagnosis, Fix, Misuse)

It checks to work situation and outside input voltage and signal of this equipment and then the result is shown

1. When you push MENU switch in Main screen.

The MAIN MENU appears.

After converting MESSAGE letter by  button, press the button .

The display appears like a screen in right side..

```

---- MESSAGES ----
ANCHOR--ALARM
ARRIVAL-ALARM
XTE---ALARM      GPS-ERR
SPEED-ALARM     DGPS-ERR
TRIP--ALARM
HIGH-VOLTAGE

```

<MESSAGES >

2. HIGH VOLTAGE and LOW VOLTAGE, GPS ERR will be displayed in the same place of the indicator.

3. Message regarding Fatal problem will be shown up with alarm.

<MESSAGE CONTENTS & SOLUTION >

ANCHOR ALARM : SET UP ANCHOR ALARM AGAIN. --> CHECK

ARRIVAL ALARM : SET UP ARRIVAL ALARM --> CHECK

XTE ALARM : SET UP XTE ALARM --> CHECK
 SPEED ALARM : SET UP SPEED ALARM --> CHECK
 TRIP ALARM : SET UP TRIP ALARM --> CHECK
 DGPS ERR : CHECK the input cable and signal --> CHECK & REPAIR
 EXP ERR : CHECK outside input DATA cable and signal --> CHECK & REPAIR
 HIGH VOLTAGE : Input voltage is so high (supply rated voltage.)
 --> REPAIR immediately
 LOW VOLTAGE : Input voltage is so low (supply rated voltage.)
 --> REPAIR immediately

6.8 SATELLITE

Indicate receiving situation of the current GPS with helping graph and picture.

1. After selecting SATELLITE FUNCTION in Main Menu screen, press **[ENT]** button.

The following pictures will be shown

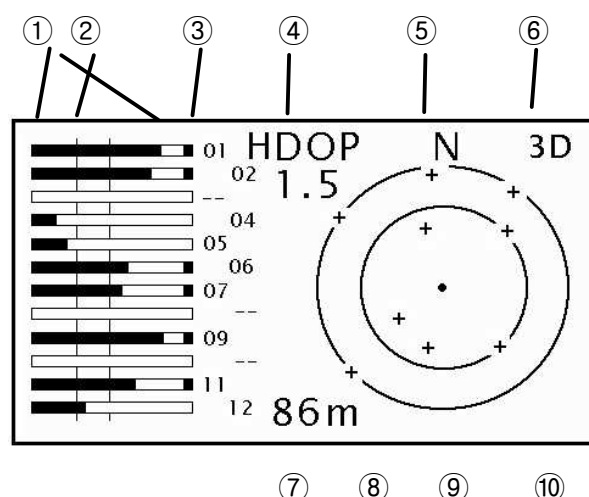

2. The Contents shown in screen are as follows.

① It indicates receiving sensitivity from total 12 Satellite. It indicates with the length of the line according to sensitivity's strength from left side to right side.

For example receiving sensitivity for No.7 satellite - It is 55 if the maximum sensitivity is 100.

* If you use satellite for determination. It displays at the right of the pole graph.

② The left line from the antenna is displayed as a level of the minimum receiving signal and the right line is displayed as a line receiving sensitivity position.

It does not use a satellite for the determination when it is not displayed with right line as it is the lowest sensitivity satellite.

③ It displays satellite number in the screen (maximum 12)

④ HDOP value is displayed.

⑤ It displays the north direction for the satellite.

⑥ It displays current condition of GPS reception.

⑦ It displays current altitude.

⑧ It displays 5' position as a line for the altitude angle of the satellite.

⑨ It displays 45' position as a line for the altitude angle of the satellite.

⑩ It displays "+" as a position of the satellite.

6.9 USER DISPLAY (User setup screen)

USER DISPLAY consists of digital display screen and Speedometer.

Display contents and display method are same with the chapter number 5 "Screen for display" and the setup method is as follows.

1. How to set up

- 1) Basic structure consists of Speedometer and Digital display screen as following picture. Every display has LARGE/TOP. LEFT/MIDDLE. RIGHT/LOWER

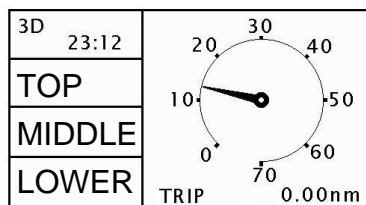

<Speedometer>

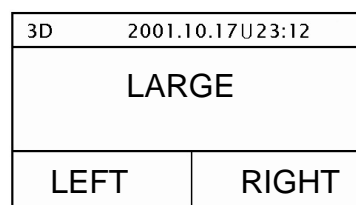

<Digital>

- 2) After choosing USER DISP in Main Menu. Press the button ENT.

It displays at right picture.

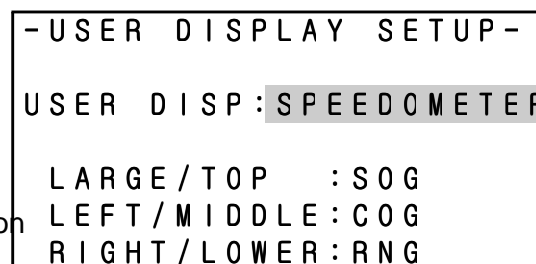

<USER DISPLAY SETUP>

- 3) Pressing ENT on USER DISP setup, it can be selected SPEEDOMETER or DIGITAL screen of USER DISPLAY setup.

- 4) After converting the letter "LARGE/TOP" by direction switch and press ENT, then the selected item is converted and displayed, from here select the wanted item by direction key and press the switch.

- 5) It is the same as 4), if you want to set up LEFT or MIDDLE and RIGHT or LOWER.

2. User's set up item

The items those can be setup by users are 3 items among of the SOG, COG, RNG, TTG, ETA, TRIP, PWR.







6.10 GPS SETUP

It sets up GPS receiving related items.

It displays as a following picture, after choosing GPS-SETUP in Main Menu by pressing ENT.

1. HOW TO SET UP

After converting the wanted letter by direction  switch and press the ENT, then the one letter flickering.

At the moment, you can select by direction switch  with  and  and select the digit by , , and press 

```

----- GPS SETUP -----
SMOOTH POS: 00
SMOOTH S/C: 00 00
AVR SPEED: 99
LAT OFFSET: +00.00'
LON OFFSET: +00.00'
FIX MODE: 2/3D +005m

```

<GPS SETUP >

2. How to setup smooth position.

It displays average value of own ship's position during the setting time.

It is reduced accidental position error. Set up available time is 0(Smoothing off) - 99.

3. SMOOTH S/C(Smoothing speed/course)

It displays average value in through GPS of the mother ship position.

It reduced accuracy error of speed and course. The left figure is speed and The right figure is the Course. Set up available time is 0(Smoothing off) - 99.

4. AVR SPEED(Speed averaging)

It has a function for calculating. It has to input speed for calculating estimated time.

And then it is set with averaged speed when the speed set up to the AUTO.

Set up time is 0(Smoothing off) - 99.

5. LAT/LON OFFSET((Latitude/Longitude position offset)



It can make correction from ± 00.00 to 99.99 minutes for latitude and Longitude.

6. FIX MODE

It sets height of antenna when it is GPS receiving mode and 2D mode.

1) At GPS receiving mode, it selects "FIX MODE" by  button, press  button, 2D or 2/3D is selected and input.

After selecting 2D or 2/3D by ,  of  button, and input to setup.

2) Setting of antenna height is applicable for GPS receiving mode 2D, press  when 2D or 2/3 D is selected in a receiving mode, then, the current display of setup antenna height is reversed and press  switch to input setting value after letting the position of the wanted numbers be flickering by right/left  button.

6.11 SYS SET-UP

Set up a list related with SYSTEM in SYS SETUP setup list. Displayed with the right screen when pressing ENT button after selecting SYS SETUP list on MAIN MENU.

```

-- SYSTEM SETUP --
DATUM : WGS - 8 4
UNITS : nm / kt-
TIME DIFF : + 0 0 : 0 0
TIME DISP : 2 4 H O U R
SIMULATOR : o f f

```

1. How to set up

Let the wanted item be converted by using direction  button and press ENT button to display the wanted item.

2. DST-CALC setup

1) DSC-CALC : It represents Great circle.

* Great Circle - Great Circle Track line between the two position on earth

2) DST-CALC : It represents Rhumb Line.

* Rhumb Line - The higher latitude line will be, the more interval of its line will be increase.





3. DATUM setup

1) Setting up coordinate drawn up by paper chart and WGS-84 is the best well known datum in the world.

2) After selecting top down direction  button and press  button to input.

The number of selectable coordinate is 171 in total and it gets ready to set up prevailing coordinates easily. Type of datum selectable is WGS-84, WGS-72, KOREA/TOKYO, NORTH AME RI1927, EUROPEAN 1950, AUSTRALIAN 1984 and ADIADAN among which ECT, SET can be selected, and pressing  button to set up the number of coordinates from 001 to 171

3) How to set ECT. SET

From Clause 2) aforesaid, when "ECT, SET" is being selected, pressing  button, then the selected Datum number will be reversed and let the wanted position of digit be flickering by left right direction  button and select the wanted digit by top down direction  button and press  button to input the setting value.

4. Setting up UNIT

It selects the display Unit and displays with the unit set in this clause for all screen.

The selectable unit is of distance unit and speed unit, one can be selected among unit of nm/kt, km/kh and mm/mh.

*After selection with top and bottom direction  switch, and press (ENT) switch then input is completed.

5. Setting up Time difference.

Time difference between world standard time and present own ship time is input and it can be input from - ~ + 3:30.

* The position of the letter (number) to be changed has to be flickering with right and left direction switch and selection of number (letter) is to be made with top and bottom switch, then press the switch to input.

6. TIME DISPLAY

It sets the methods of time display for all screens, it can select either 24 hour display method or 12 hour display method.

In 12 hour display method, it displays "01:25P" (A stands for a.m while P stands for p.m).

In 24 hour display method. It displays "13:25".

"U13:25" stands for UTC time and "L13:25" stands for Local time.

* After selection made by top and bottom switch, press (ENT) switch, then it is input.

7. SIMULATOR

It is used for learning how to operate. When this item is selected. GPS receiver is not used for position information and it can be operated SIMULATOR information inside machine. When operator wants to stop the activation, he should turn off the power and again either turn on the power or set up "off" in the setting menu.

When SIMULATOR is working, left top side in LCD display shows "SIM" and flickering so that it tells from normal working. This letter can be displayed in every screen mode. (except Menu screen).

1) Under the condition that letter of "SIMULATOR" is opposite by top and bottom direction

⊕ switch, press (ENT) switch and select the one among "off", "low", "mid", "high" by top and bottom direction ⊕ switch and press (ENT) switch.

Then, input will be done.

* Off in setting value is normal operation condition without using SIMULATOR and it is always set "off" when the power is off. Low, mid, high is SIMULATOR speed.

6.12 I/O SET-UP

In the item of I/O SET-UP, INPUT and OUTPUT related item can be set up and data of waypoints and route can be put through PC.

After selection of I/O SETUP in main MENU screen, press (ENT) switch and the following screen is displayed.

1. INPUT DATA

This is for setting up whether GPS DATA can be used by either GPS Receiver or other external system, when it is setup with external system.

"EXTERNAL" is displayed on the position of DATUM in the Main Screen.

```

----- I / O  SETUP -----
INPUT DATA : INTERNAL
OUT FORMAT : NMEA-V2.0
SAVE WP/RUT
LOAD WP/RUT

```

1) Way of setup

After letting "INPUT DATA". to be opposite by direction switch. press the (ENT) switch, then the present set contents will be displayed in opposite.

After selection either "EXTERNAL" or "INTERNAL" by direction switch, press (ENT) switch, then set up is completed.

2. Setup OUT FORMAT

It sets up output methods when GPS data is put through EXTERNAL SYSTEM.

1) FORMAT SETUP

After "OUT FORMAT" is reversed by shift key. If press(ent), setup's contents is reversed. After selecting changable table by up-down shift key, if press ENT selected table do setup.

2) Setting modes are NMEA-V1.5, NMEA-V2.0, FURUNO CIF. Among them, can select one.

3) Possible to make ON/OFF of GPHT ignal

3. SAVE WP/RUT

If press ENT this items, show as left-picture.

1) After WPT DATA is reversed by up-down shift key, if press (ent), stored WAYPOINTS DATA outputs to outside device(PC).

When output, output WAYPOINTS number shows left-display *When output, if pressing "MENU". immediately stop, return to WAYPOINTS, ROUTE.

```

  --- SAVE WP/RUT ---
WPT DATA      001
RUT DATA
  
```

<WAYPOINTS, ROUTE>

* When output, if pressing "MENU". immediately stop, return to WAYPOINTS, ROUTE.

2) ROUTE output

After RUT DATA is reversed by up-down shift key, if press (ent) key, stored ROUTE DATA outputs to outside device(PC). When output, output ROUTE Number shows to right-display. When output, if pressing "MENU", immediately stop return to WAYPOINTS/ROUTES.

4. LOAD WP/RUT

LOAD WP/RUT

If press (ent) show as right-picture.

1) WAYPOINTS input

After WPT DATA is reversed by-down shift key, if press (ent) key, WAYPOINT DATA inputs to inside momory from PC.

When input, WAYPOINTS number shows right-display, when standby, show "WAIT".

When input or standby, if press "MEMU" key, immediately stop. Return to WAYOINTS, ROUTE.

2) ROUTE input

After RUT DATA is reversed by up-down shift key, if press (ent) key, WAYPOINT DATA puts to inside memory from PC.

When input, ROUTE number shows right-display. When standby, "WAIT".

* When input or standby, if press "MEMU" key, immediately stop. Return to WAYPOINTS, ROUTE.

```

  --- LOAD WP/RUT ---
WPT DATA    Wait
RUT DATA
  
```

5. FORMAT

1) INPUT DATA FORMAT(when it is EXTERNAL)

When input GPS DATA from outside, input as follows

(According to Ver1.5 and Ver2.0 of NMEA-0183)

*. NMEA-V1.5

\$GPGGA,005630,3505.251,N,12902.339,E,1,3,001,,M,,M<cr><lf>

\$GPGLL,3505.25,N,12902.34,E<cr><lf>

\$GPVTG,258,T,264,M,00.7,N,01.4,K<cr><lf>

\$GPZDA,005630,30,05,1933,+09<cr><lf>

\$GPODA,P,025.1<cr><lf>

*. NMEA-V2.0

\$GPGGA,063258.00,3505.1701,N,12904.2314,E,1,05,02.5,,M,,M,,*6A<cr><lf>

\$GPGLL,3505.1701,N,12904.2314,E,063258.00,A*00<cr><lf>

\$GPRMC,063258.00,A,3505.1701,N,12904.2314,E,00.2,134.8,281201,,*03<cr><lf>

\$GPVTG,134.8,T,141.7,M,00.2,N,00.3,K*42<cr><lf>

\$GPZDA,063258,28,12,2001,+09,00*6C<cr><lf>

2) OUT FORMAT (external output type)

*. NMEA-V1.5

\$GPGGA,063137,3505.169,N,12904.227,E,1,05,02.1,,M,,M<cr><lf>

\$GPGLL,3505.169,N,12904.227,E<cr><lf>

\$GPRMC,063137,A,3505.169,N,12904.227,E,00.3,070.3,281201,,<cr><lf>

\$GPVTG,070.3,T,077.2,M,00.3,N,00.5,K<cr><lf>

\$GPZDA,063137,28,12,2001,+09<cr><lf>

*. NMEA-V2.0

\$GPGGA,063258.00,3505.1701,N,12904.2314,E,1,05,02.5,,M,,M,,*6A<cr><lf>

\$GPGLL,3505.1701,N,12904.2314,E,063258.00,A*00<cr><lf>

\$GPRMC,063258.00,A,3505.1701,N,12904.2314,E,00.2,134.8,281201,,*03<cr><lf>

\$GPVTG,134.8,T,141.7,M,00.2,N,00.3,K*42<cr><lf>

\$GPZDA,063258,28,12,2001,+09,00*6C<cr><lf>

*. FURUNO CIF

FURUNO-CIF+00=<STX><11019930219133530G+0900>

FURUNO-CIF+24=<FS><240N350525E12902340000>

FURUNO-CIF+47=<FS><44+0993590><ETX>

3) WP/RUT DATA (PC) (Uploading Downloading)

* WAYPOINTS DATA

\$SAWPT,001,WPT-001 ,00,3504.975,N,12904.397,E*02<cr><lf>

a b c d e f

↳a -> WAYPOINTS MARK (000~999까지)

↳b -> WAYPOINTS MARK

↳c -> MARK (00~99)

↳d -> latitude 00 00 000 N/S
 ↳e -> longitude 00 00 000 E/W
 ↳f -> Error Check 2 Code
 ↳<cr><lf> -> ESC and CLOSE

* ROUTE DATA

\$SARUT,01, _____,09,001*78<cr><lf>

 a b c d e

↳a -> ROUTES (00~99)
 ↳b -> ROUTES (8)
 ↳c -> WAYPOINTS (00~99)
 ↳d -> WAYPOINTS (000~999)
 ↳e -> Error Check 2 Code
 ↳<cr><lf> -> ESC and CLOSE

6. OUTSIDE INPUT/OUTPUT TEST (short of outside input/output data connector)

- 1) Main display ----> ◀ + ▶ ----> MENU  <I/O SETUP> ----> ENT ----> ENT
- 2) If there is no any defaults on communication line of SPR-1400 main unit, GOOD message is shown and Error is shown if there is any defaults.

CHAPTER 7. ATTACHMENT

1. Geodetic Datum

International Geodetic Datum		1/4
001 WGS-84		
002 WGS-72		
003 TOKYO	Mean Value (Japan, Korea & Okinawa)	
004 NORTH AMERICAN 1927	Mean value (CONUS)	
005 EUROPEAN 1950	Mean value	
006 AUSTRALIAN GEODETIC 1984	Australia and Tasmania Island	
007 ADIADAN	Mean Value	
008	Ethiopia	
009	Mali	
010	Senegal	
011	Sudan	
012 AGF	Somalia	
013 AIN EL ABD 1970	Bahrain Island	
014 ANNA 1 ASTRO 1955	Cocos Island	
015 ARC 1950	Mean Value	
016	Botswana	
017	Lesotho	
018	Malawi	
019	Swaziland	
020	Zaire	
021	Zambia	
022	Zimbabwe	
023 ARC	Mean Value (Kenya & Tanzania)	
024	Kenya	
025	Tanzania	
026 ASCENSION ISLAND 1958	Ascension Island	
027 ASTRO BECON "E"	Iwo Jima Island	
028 ASTRO B4 SOR. ATOLL	Tern Island	
029 ASTRO POS 714	St. Helena Island	
030 ASTRONOMIC STATION 1952	Marcus Island	
031 AUSTRALIAN GEODETIC 1966	Australia and Tasmania Island	
032 BELLEVUE(IGN)	Efate and Erromango Islands	
033 BERMUDA 1957	Bermuda Islands	
034 BOGOTA OBSERVATORY	Columbia	
035 CAMPO INCHAUPE	Argentina	
036 CANTON ISLAND 1966	Phoenix Island	
037 CAPE	South Africa	
038 CAPE CANAVERAL	Mean Value (Florida & Bahama Islands)	
039 CARTHAGE	Tunisia	
040 CHATHAM 1971	Chatham Island (New Zealand)	

International Geodetic Datum		2/4
041 CHUA ASTRO	Paraguay	
042 CORREGO ALEGRE	Brazil	
043 DJAKARTA (BARAVIA)	Sumatra Island (Indonesia)	
044 DOS 1968	Gizo Island (New Georgia Island)	
045 EASTER ISLAND 1967	Easter Island	
046 EUROPEAN 1950 (Cont'd)	Western Europe	
047	Cyprus	
048	Egypt	
049	England, Scotland, Channel & Shetland Islands	
050	England, Scotland, Channel & Shetland Islands	
051	Greece	
052	Iran	
053	Italy-Sardinia	
054	Italy-Sicily	
055	Norway and Finland	
056	Portugal and Spain	
057 EUROPEAN 1979	Mean Value	
058 GANDAJIKA BASE	Republic of Maldives	
059 GEODETIC DATUM 1949	New Zealand	
060 GUAM 1963	Guam Island	
061 GUX 1 ASTRO	Guadalcanal Island	
062 HJORSEY 1955	Iceland	
063 HONG KONG 1963	Hong Kong	
064 INDIAN	Thailand and Vietnam	
065	Bangladesh, India and Nepal	
066 IRELAND	Ireland	
067 ISTS 073 ASTRO 1969	Diego Garcia	
068 JHONSTON ISLAND 1961	Jhonston Island	
069 KANDAWALA	Sri Lanka	
070 KERGUELEN ISLAND	Kerguelen Island	
071 KERTAU 1948	West Malaysia and Singapore	
072 LA REUNION	Mascarene Island	
073 L.C. 5 ASTRO	Cayman Brac Island	
074 LIBERIA 1964	Liberia	
075 LUZON	Philippines (Excluding Mindanao Island)	
076	Mindanao Island	
077 MAHE 1971	Mahe Island	
078 MARCO ASTRO	Salvage Islands	
079 MASSAWA	Eritrea (Ethiopia)	
080 MERCHICH	Morocco	
081 MIDWAY ASTRO 1961	Midway Island	
082 MINNA	Nigeria	
083 NAHRWAN	Masirah Island (Oman)	
084	United Arab Emirates	
085	Saudi Arabia	
086 NAMIBIA	Namibia	
087 MAPARIMA,BWI	Trinidad and Tobago	
088 NORTH AMERICAN 1927	Western United States	
089	Eastern United States	
090	Alaska	

International Geodetic Datum		3/4
091	Bahamas (Excluding San Salvador Island)	
092	Bahamas-San Salvador Island	
093 NORTH AMERICAN 1927	Canada (Including Newfoundland Island)	
094	Alberta and British Columbia	
095	East Canada	
096	Manitoba and Ontario	
097	Northwest Territories and Saskatchewan	
098	Yukon	
099 NORTH AMERICAN 1927	Canal Zone	
100	Caribbean	
101	Central America	
102	Cuba	
103	Greenland	
104	Mexico	
105 NORTH AMERICAN 1983	Alaska	
106	Canada	
107	CONUS	
108	Mexico, Central America	
109 OBSERVATORIO 1966	Corvo and Flores Islands (Azores)	
110 OLD EGYPTIAN 1930	Egypt	
111 OLD HAWAIIAN	Mean Value	
112	Hawaii	
113	Kauai	
114	Maui	
115	Oahu	
116 OMAN	Oman	
117 Ordnance Survey of Great Britain 1936	Mean Value	
118	England	
119	England, Isles of Man and Wales	
120	Scotland and Shetland Islands	
121	Wales	
122 PICO DE LAS NIVIES	Canary Islands	
123 PITACAIRN ASTRO 1967	Pitacaim Island	
124 Provisional South Chilean 1963	South Chile (near 53'S)	
125 Provisional South American 1956	Mean Value	
126	Bolivia	
127	Chile-Northern Chile (near 19'S)	
128	Chile-Southern Chile (near 19'S)	
129	Colombia	
130	Ecuador	
131	Guyana	
132	Peru	
133	Venezuela	
134 PUERTO RICO	Puerto Rico and Virgin Islands	
135 QATAR NATIONAL	Qatar	
136 QORNOQ	South Greenland	
137 ROME 1940	Sardinia Islands	
138 SANTA BRAZ	Sao Maguel, Santa Maria Islands (Azoes)	
139 SANTO (DOS)	Espirito Santo Island	
140 SAPPER HILL 1943	East Falkland Island	

International Geodetic Datum		4/4
141 SOUTH AMERICAN 1969	Mean Value	
142	Argentina	
143	Bolivia	
144	Brazil	
145	Chile	
146	Columbia	
147	Ecuador	
148	Guyana	
149	Paraguay	
150	Peru	
151	Trinidad and Tobago	
152	Venezuela	
153 SOUTH ASIA	Singapore	
154 SOUTHEAST BASE	Porto Santo and Madeira Islands	
155 SOUTHWEST BASE	Faial, Graciosa, Pico, Sao Jorge and Terceira Island	
156 TIMBALAI 1948	Brunei and East Malaysia (Sarawak & Sadah)	
157 TOKYO	Japan	
158	Korea	
159	Okinawa	
160 TRISTAN ASTRO 1968	Tristan da Cunha	
161 VITI LEVU 1916	Viti Levu Island (Fiji Islands)	
162 WAKE-ENISETOK 1960	Marshall Islands	
163 ZANDERIJ	Suriname	
164 BUKIT RIMPAH	Bangka and Belitung Islands (Indonesia)	
165 CAMP AREA ASTRO	Camp Memurdo Area, Antarctica	
166 G.SEGARA	Kalimantan Islands (Indonesia)	
167 HEART NORTH	Afghanistan	
168 HU-TZU-SHAN	Taiwan	
169 Tananarive Observatory 1925	Madagascar	
170 YUCARE	Urguay	
171 RT90	Sweden	

2. Geodetic Datum

International Geodetic Datum

00	WGS-84	42	TUNISIA
01	WGS-72	43	CHATHAM
02	TOKYO	44	PARAGUAY
03	NAD-27	45	BRAZIL
04	ALASKA/CANADA	46	NEW GEORGIA
05	EUROPEAN 50	47	EASTER
06	AUSTRALIAN 84	48	MALDIVE
07	SOUTH ASIA	49	GUAM 63
08	SOUTH AMERICA	50	GUADAL CANAL
09	GREENLAND	51	HONG KONG 63
10	NAD-83	52	DIEGO GARCIA
11	ICELAND 55	53	JOHNSTON
12	ICELAND 65	54	SRI LANKA
13	NEW ZEALAND	55	KELGUELEN
14	EUROPEAN 79	56	CAYMAN BRAC
15	ROME 40	57	LIBERIA 64
16	SOUTH AFRICA	58	MAHA 71
17	SAUDI ARABIA	59	SALVAGE
18	INDIAN/NEPAL	60	ERITREA
19	PHILLIPPINES	62	MIDWAY 61
20	ENGLAND	63	NIGERIA
21	HAWAII	64	TRINIDAD
22	DJAKARTA	65	CORVO/FLORES
23	MALAYSIA	66	EGYPT
24	JAPAN	67	OMAN
25	ETHIOPIA	68	CANARY
26	SOMALIA	69	PITCAIRN
27	BAHRAIN	70	SOUTH CHILE
28	COCOS	71	PUERTO RICO
29	ARC 50	72	QATAR
30	ARC 60	73	MASCARENE
31	ASCENSION	74	SANTO
31	MOROCCO	75	SANTA MARIA
32	IWO JIMA	76	EAST FALKLAND
33	TERN	77	PORTO SANTO
34	ST.HELENA	78	FAIAL
35	MARCUS	79	EAST MALAYSIA
36	EFATE	80	TRISTAN
37	BERMUDA	81	FIJI
38	COLOMBIA	82	MARSHALL
39	ARGENTINA	83	SURINAM
40	PHOENIX	84	FINLAND
41	FLORIDA	85	SWEDEN

3. EXPLANATION OF MANUAL CODE

AVR (Arrival) : arrival notice is marked in caution function

ANC (Anchor) : Anchor notice is marked in caution function

BRG (Bearing from own ship to destination waypoint) : Direction of destination is marked in current location

COG (Course Over the Ground) : Moving direction of current vessel is marked

DR (Dead Reckoning) : Marked it when impossible to receive GPS

DGPS (Differential Global Positioning System) : Receiving equipment using satellite (the location of receiver which is known the location already is a basic)

DOP (Dilution of Precision) : Dimensionless numbers shown errors effecting location conclusion of geometry of satellites

GDOP (Geometric Dilution of Precision) : Geometric precision

HDOP (Horizontal Dilution of Precision) : Precision of horizontal direction

PDOP (Position Dilution of Precision) : Precision of location's conclusion

TDOP (Time Dilution of Precision) : Precision of sight

ETA (Estinated Time of Arrival at destination) : Expected Time of arrival at destination

GPS (Global Positioning System) : Location receiver using satellites

IMO (International Telecommunication Organization)

ITU-R(International Telecommunication Union - Radio Communication)

LAT (Latitude)

LON (Longitude)

MSC (Maritime Safety Committee)

MOB (Man Overboard)

PC (Personal Computer)

PWR (Power)

RTCM (Radio Technical Commission Maritime Services)

RNG (Range from own ship to destination)

SPS (Standard Positioning Service)

SOG (Speed Over the Ground)

TTG (Time-To-Go) : ETA from current location and can mark to max. 99hours 59minutes

TRIP (Trip Distance) : Display the distance of course deviation with numbers on voyage

UTC (Universal Time Coordinated) :

XTE (Cross-track error) : Course deviation

CHAPTER 8. BLOCK DIAGRAM

1. SYSTEM CONFIGURATION
2. INTERNAL DIAGRAM
3. EXTERNAL DIAGRAM (GPS GPS -1400)
4. EXTERNAL DIAGRAM (DGPS SPR-1400)
5. INSTALLATION DRAWING FOR DEL타
6. INSTALLATION DRAWING FOR CEILING
7. EXTERNAL DRAWING FOR SAN-60 (GPS ANTENNA)
8. EXTERNAL DRAWING FOR SANB-300 (DGPS ANTENNA)
9. PACKING LIST (SPR - 1400)
10. PACKING LIST (DSPR-1400)

